

Seiten insgesamt:

49

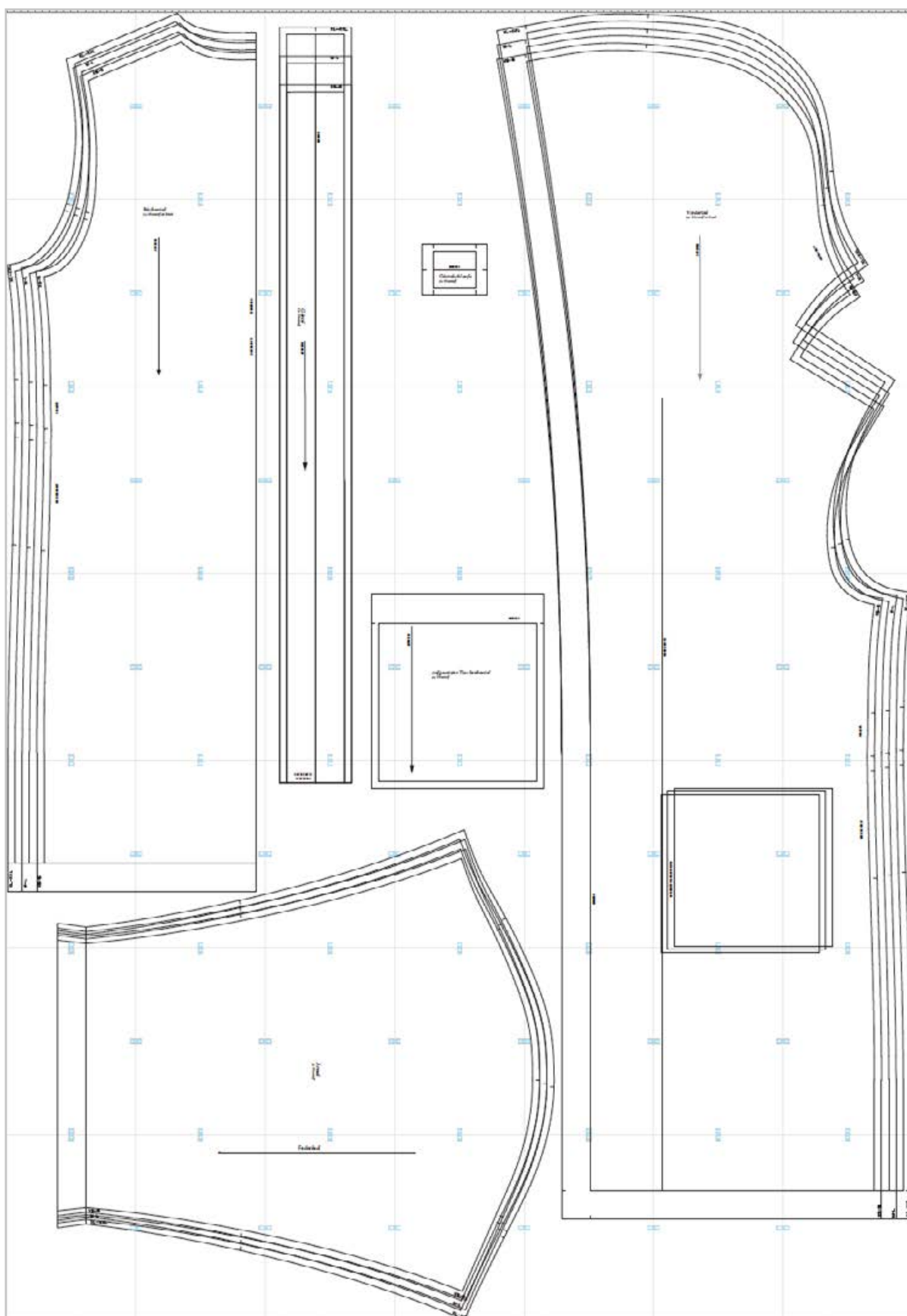

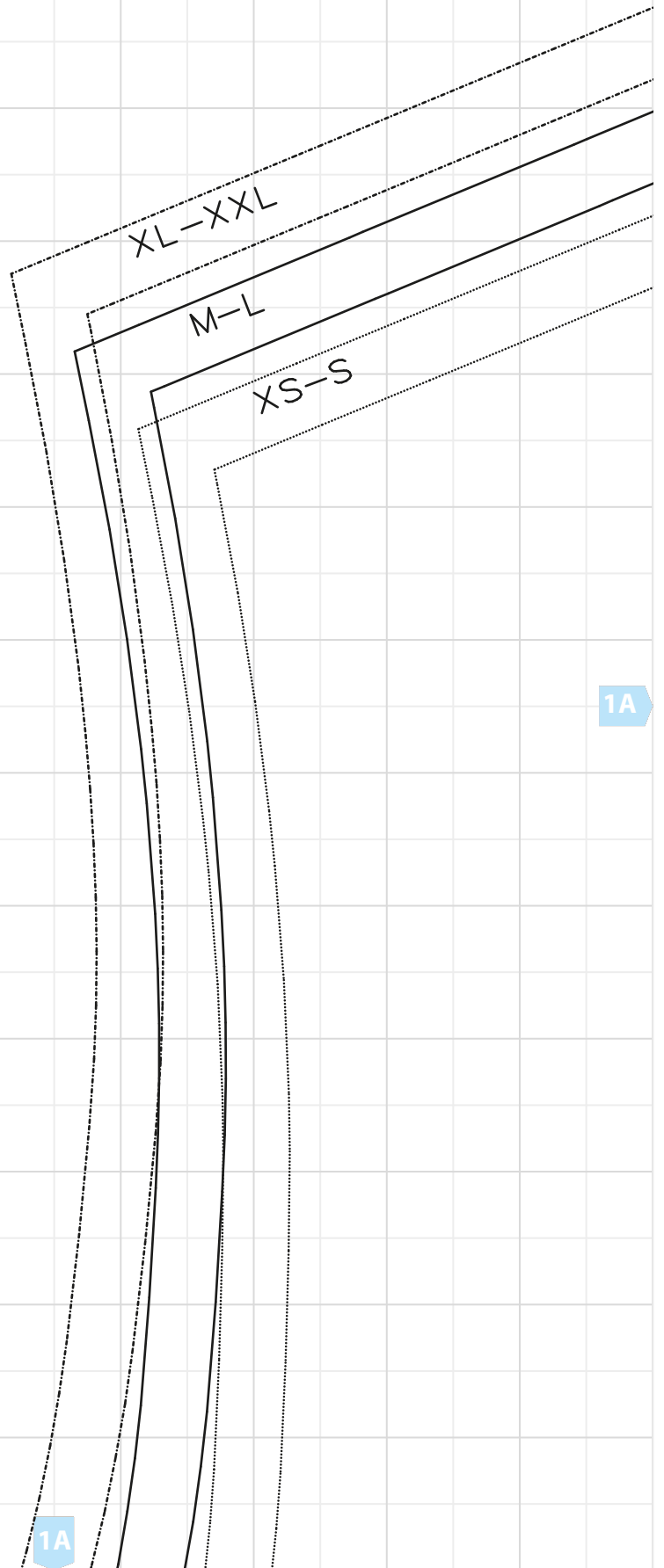

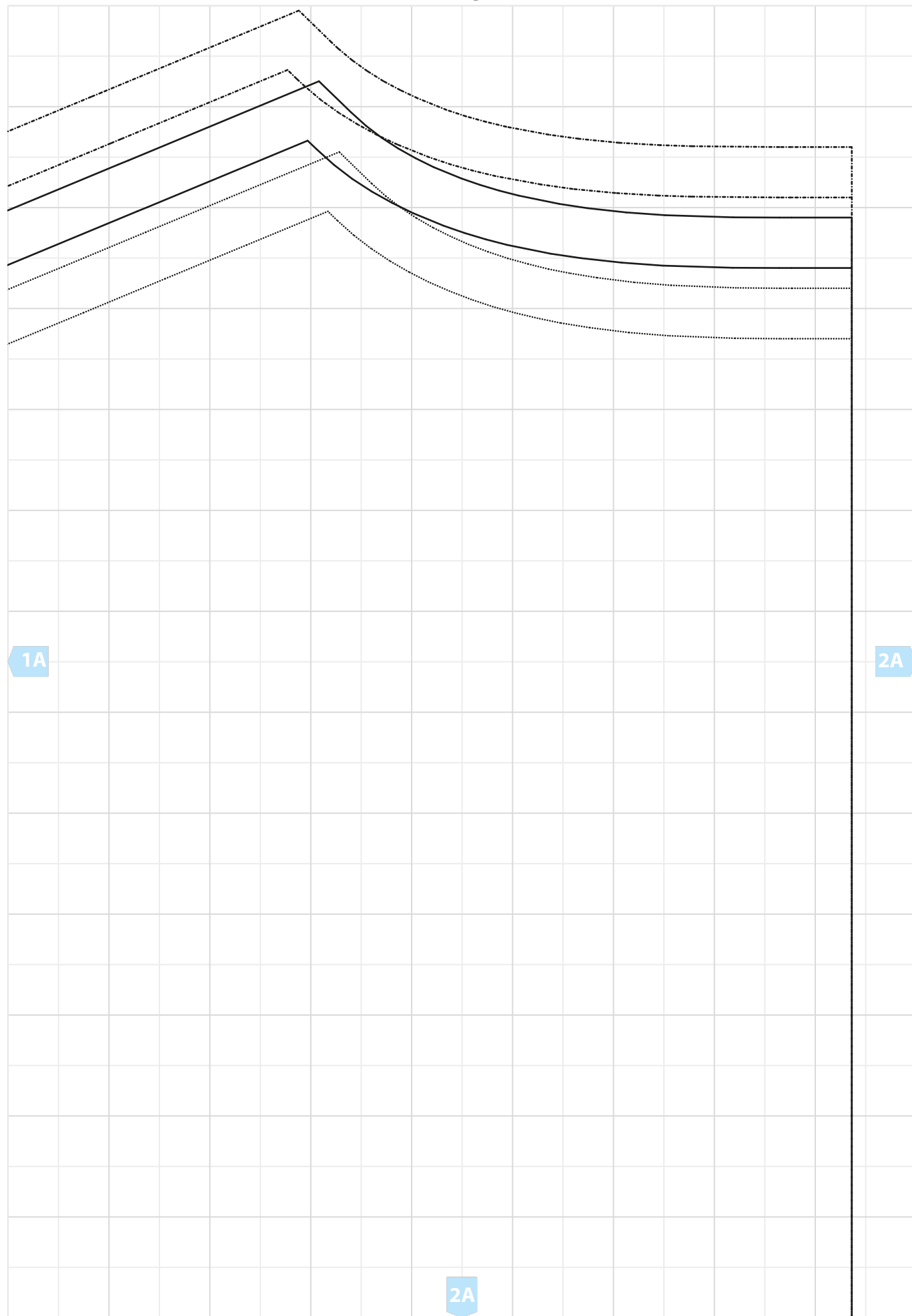

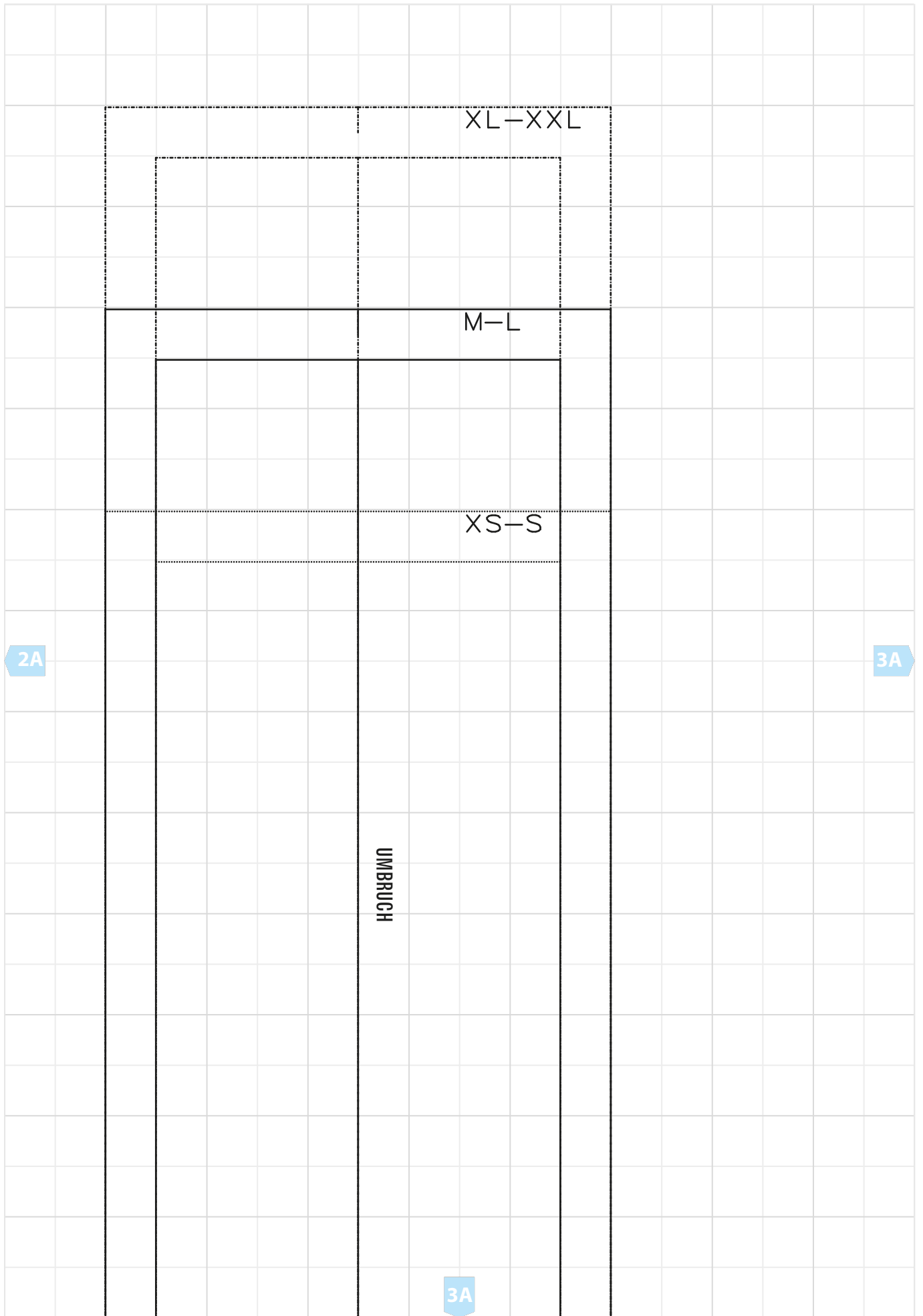

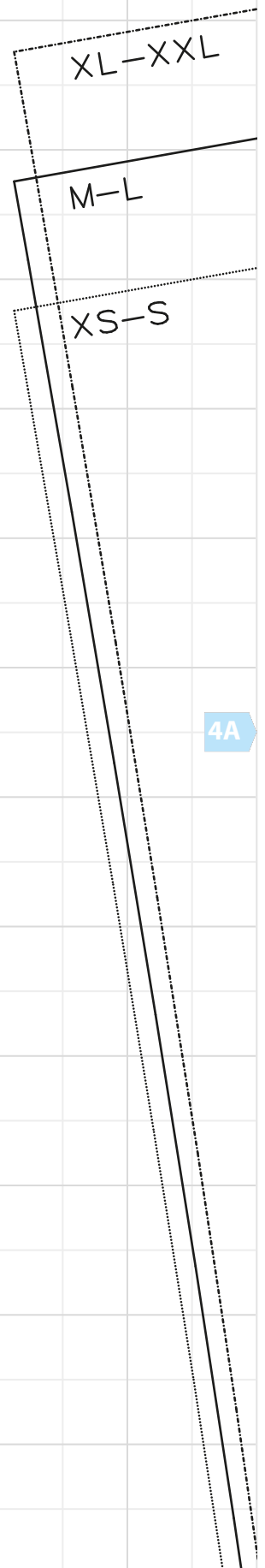

3A

4A

4A

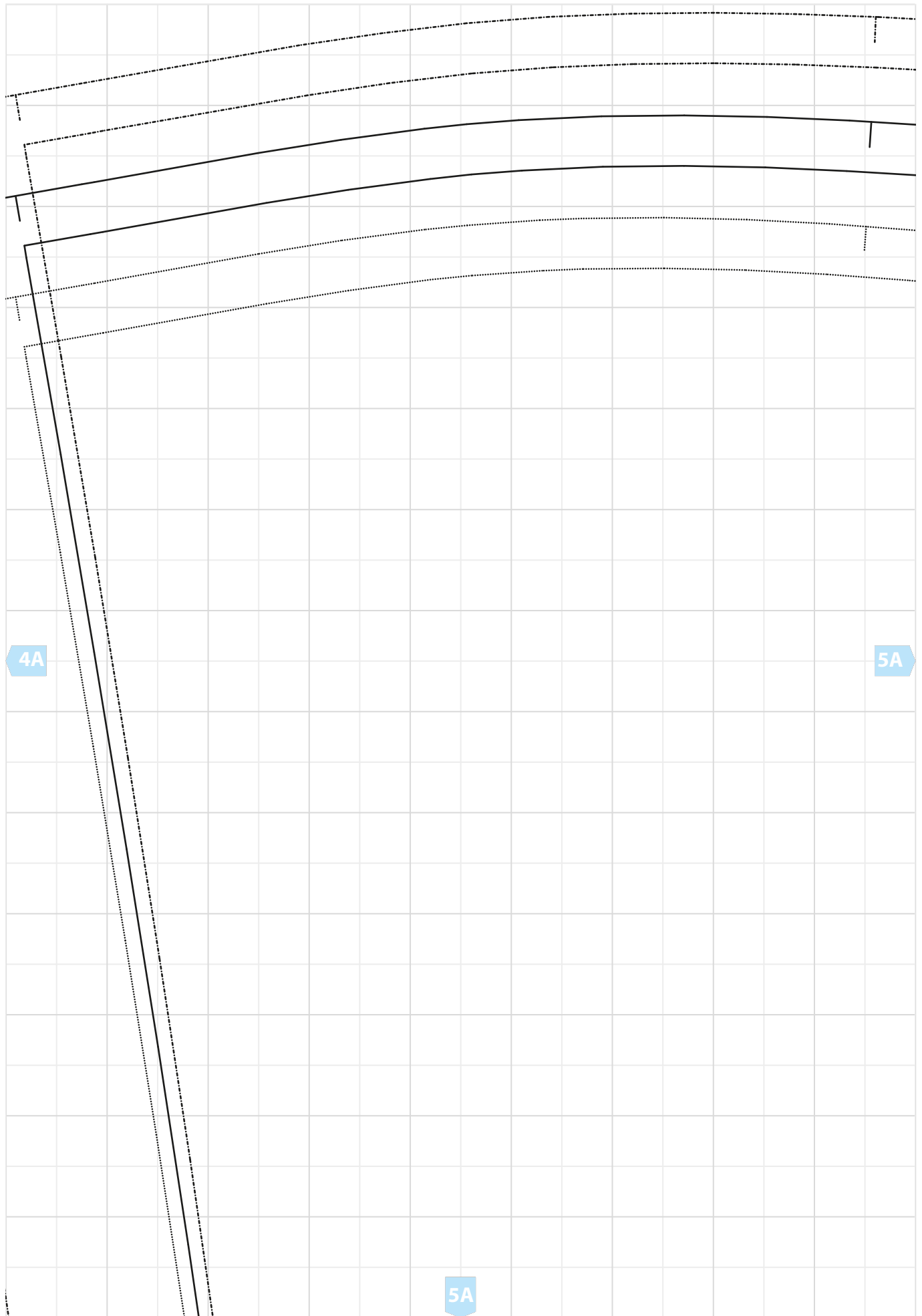

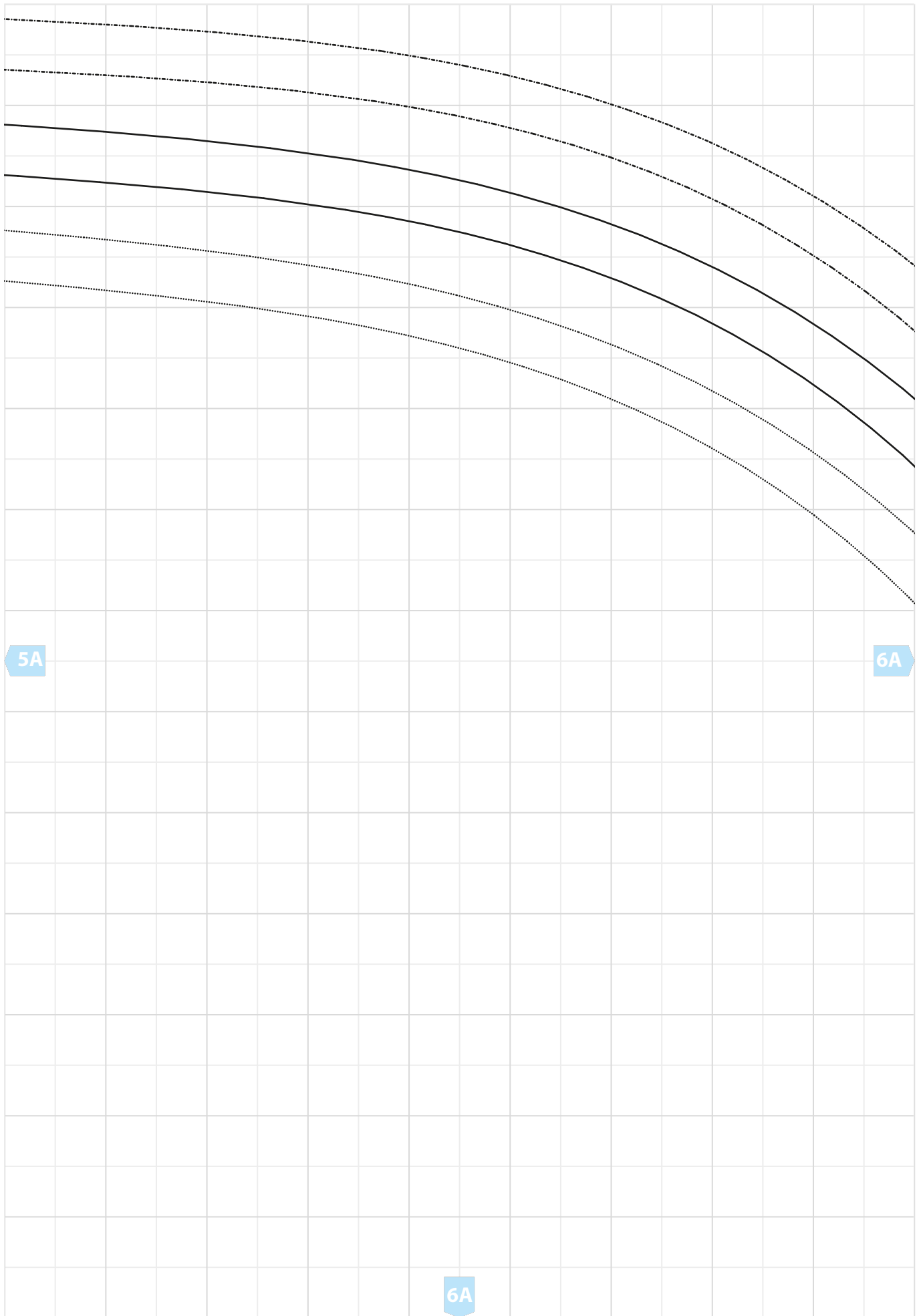

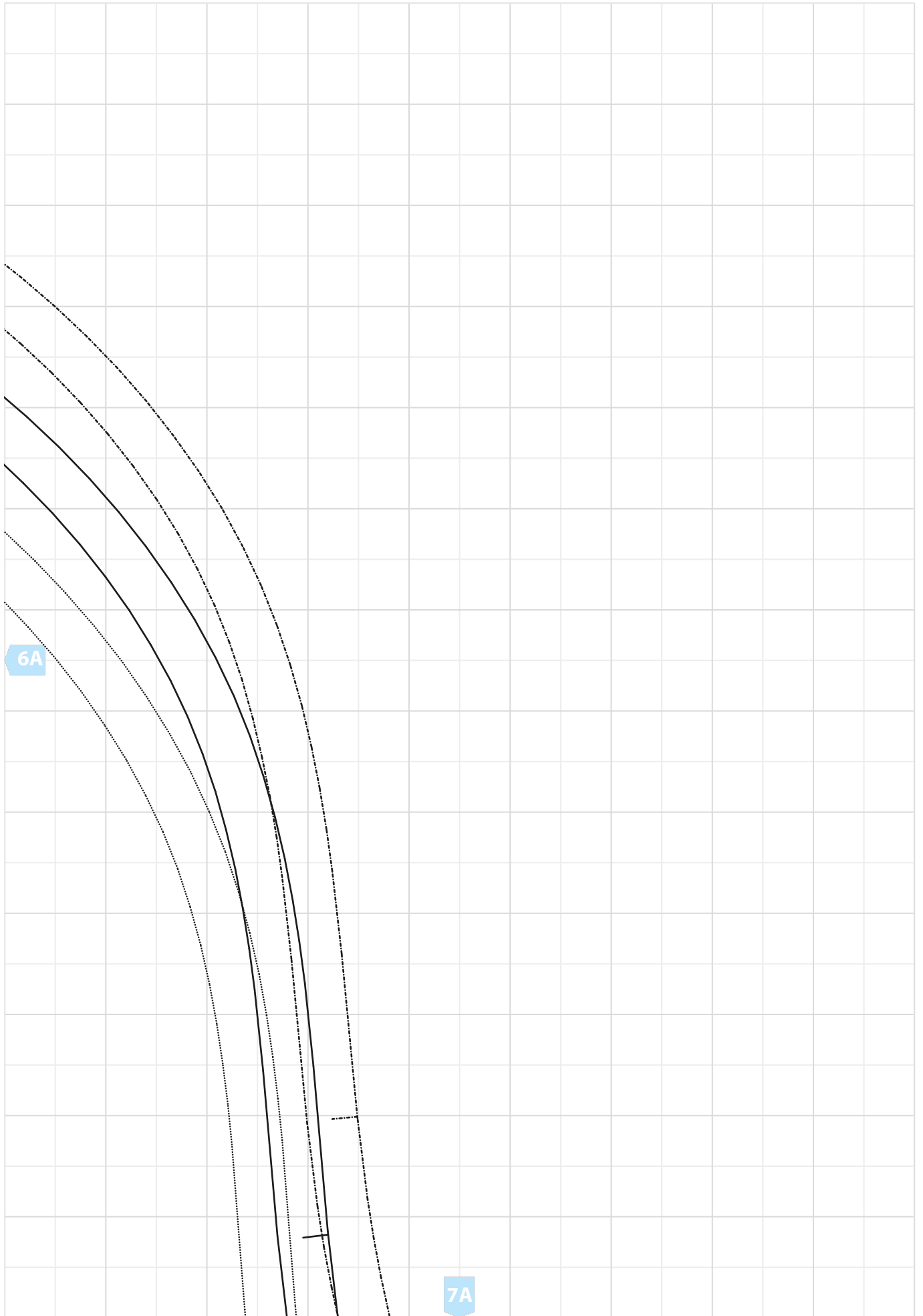

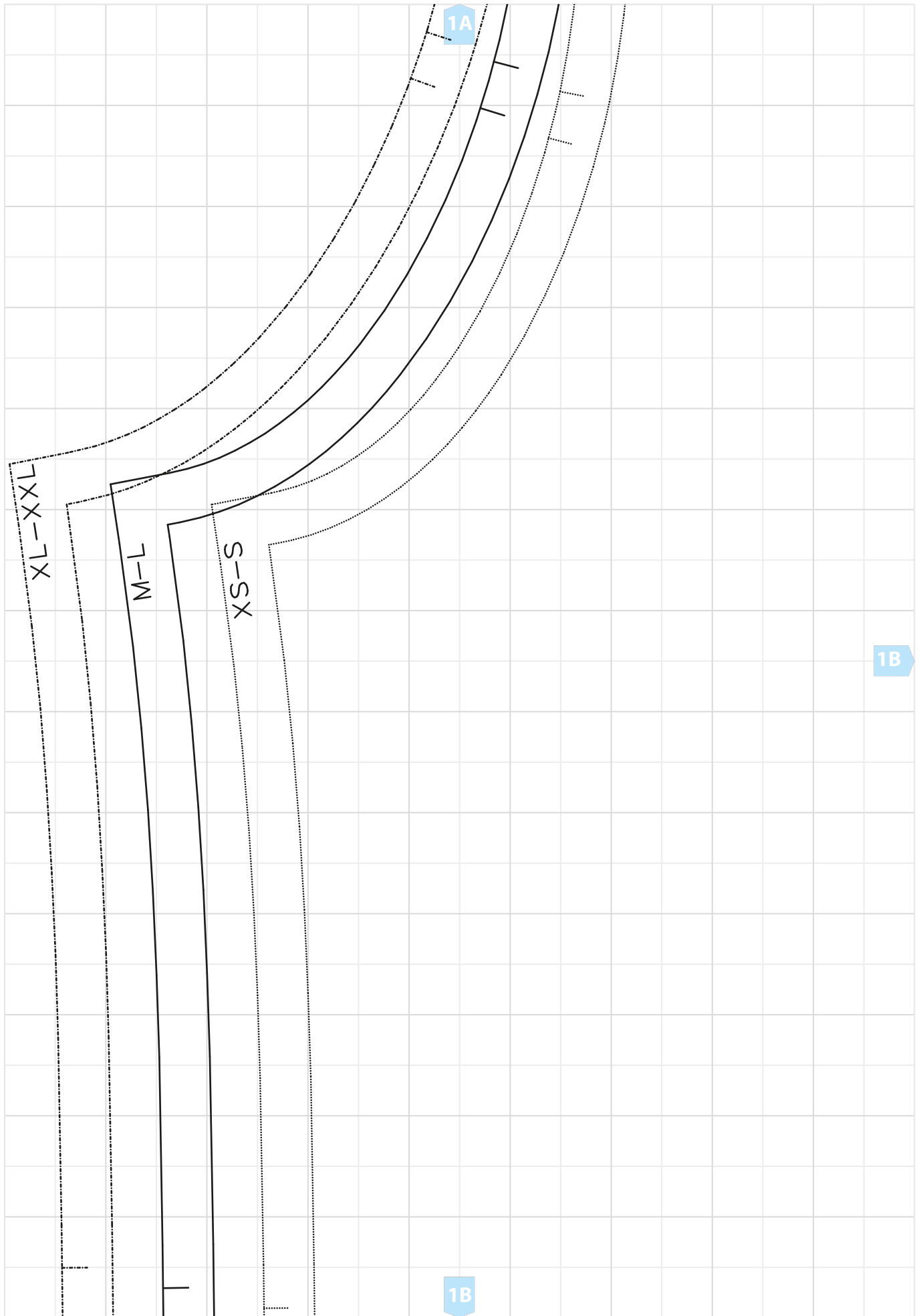

2A

Rückenteil
1x Oberstoff im Bruch

FADENLAUF

1B

2B

STOFFBRUCH

HINTERE MITTE

2B

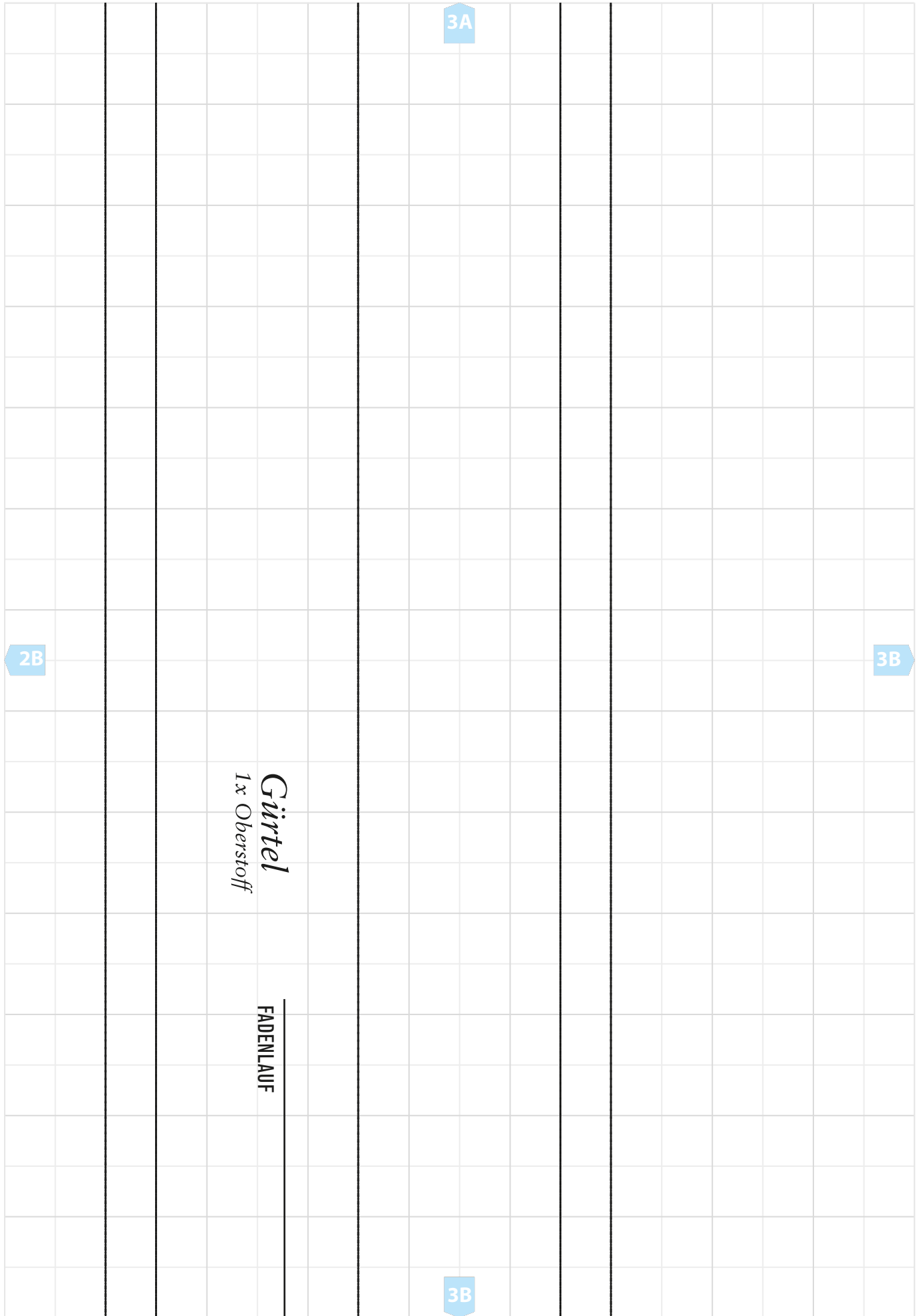

3A

2B

3B

Gürtel
1x Oberstoff

FADENLAUF

3B

4A

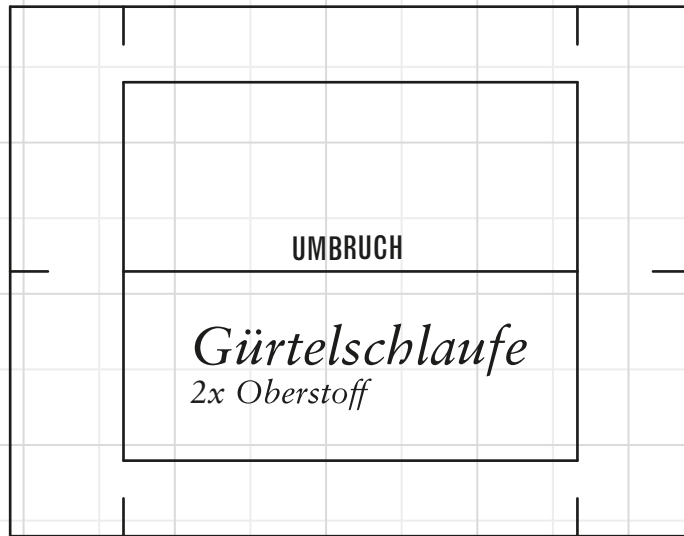

3B

4B

4B

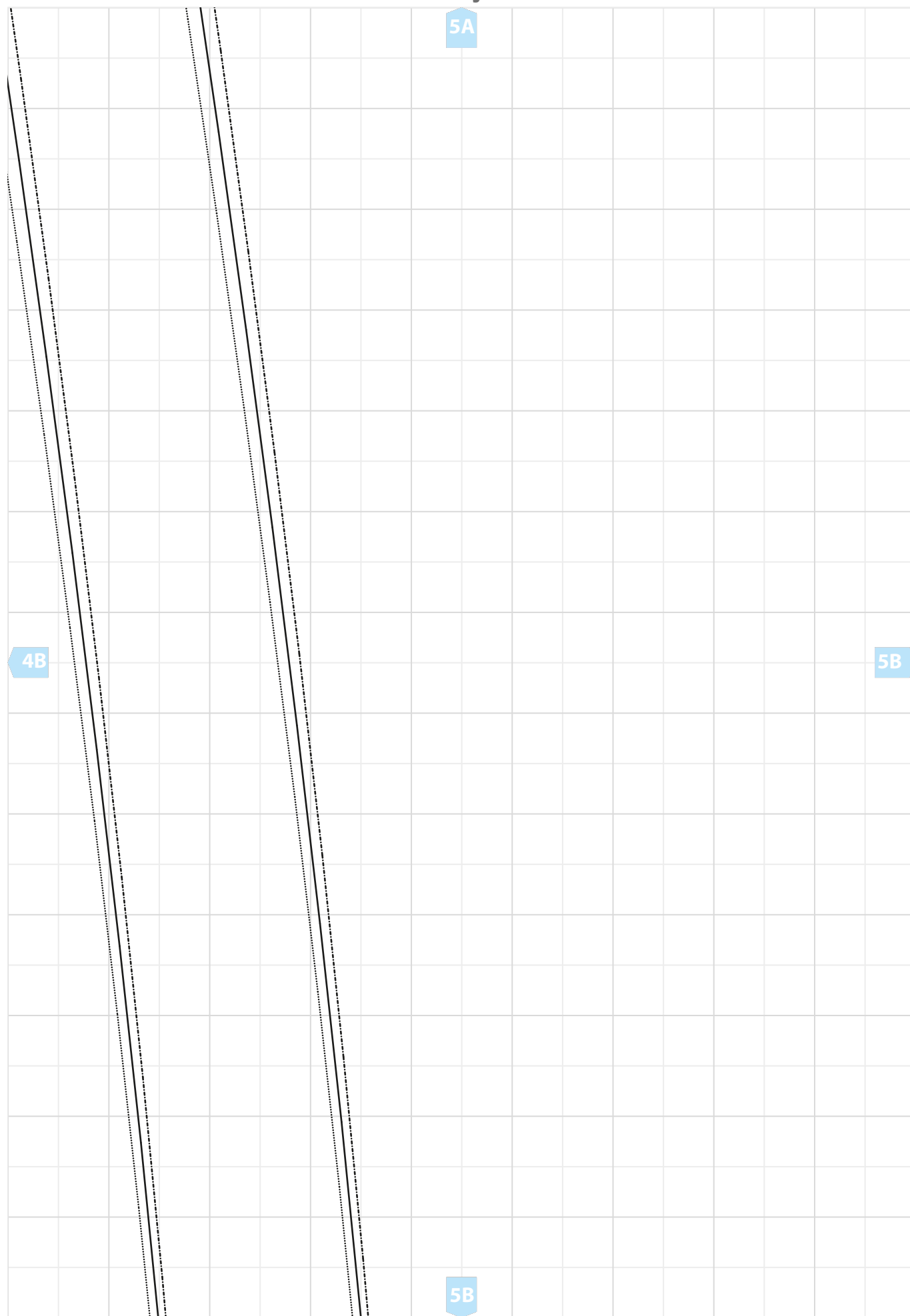

5A

4B

5B

5B

6A

Vorderteil
2x Oberstoff im Bruch

FADENLAUF

5B

6B

6B

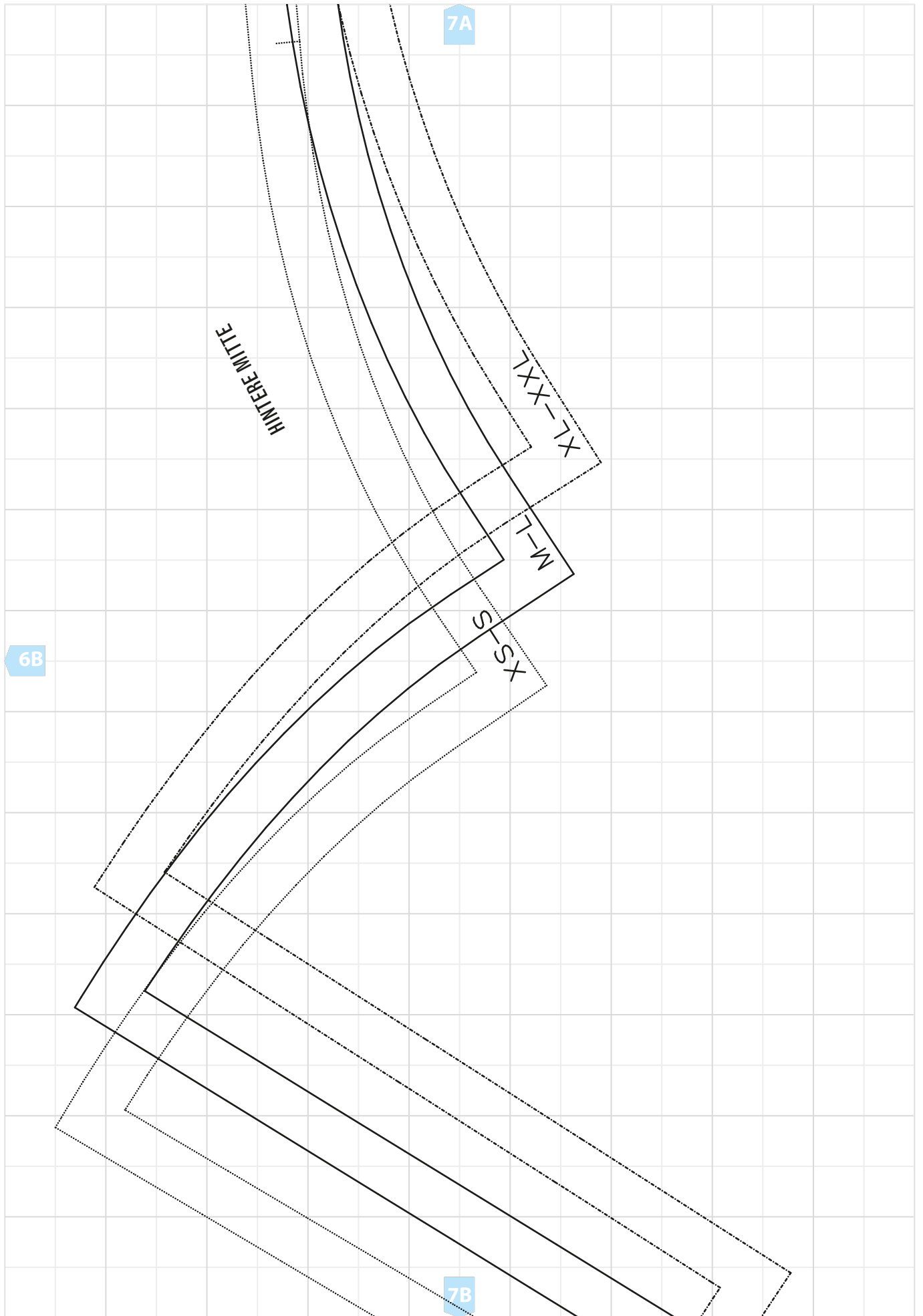

1B

SCHLAUFE

TASCHEINGRIFF

1C

1C

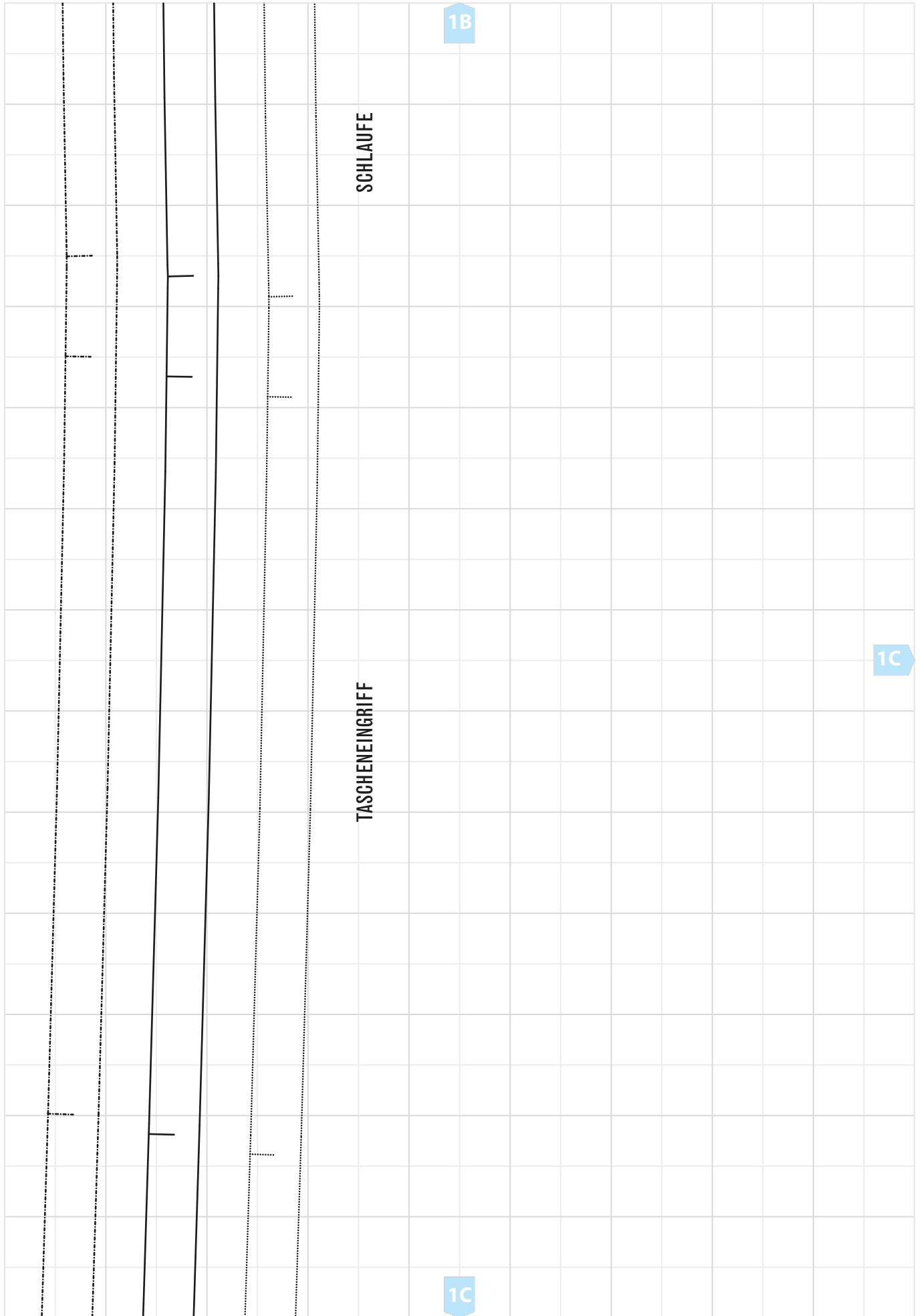

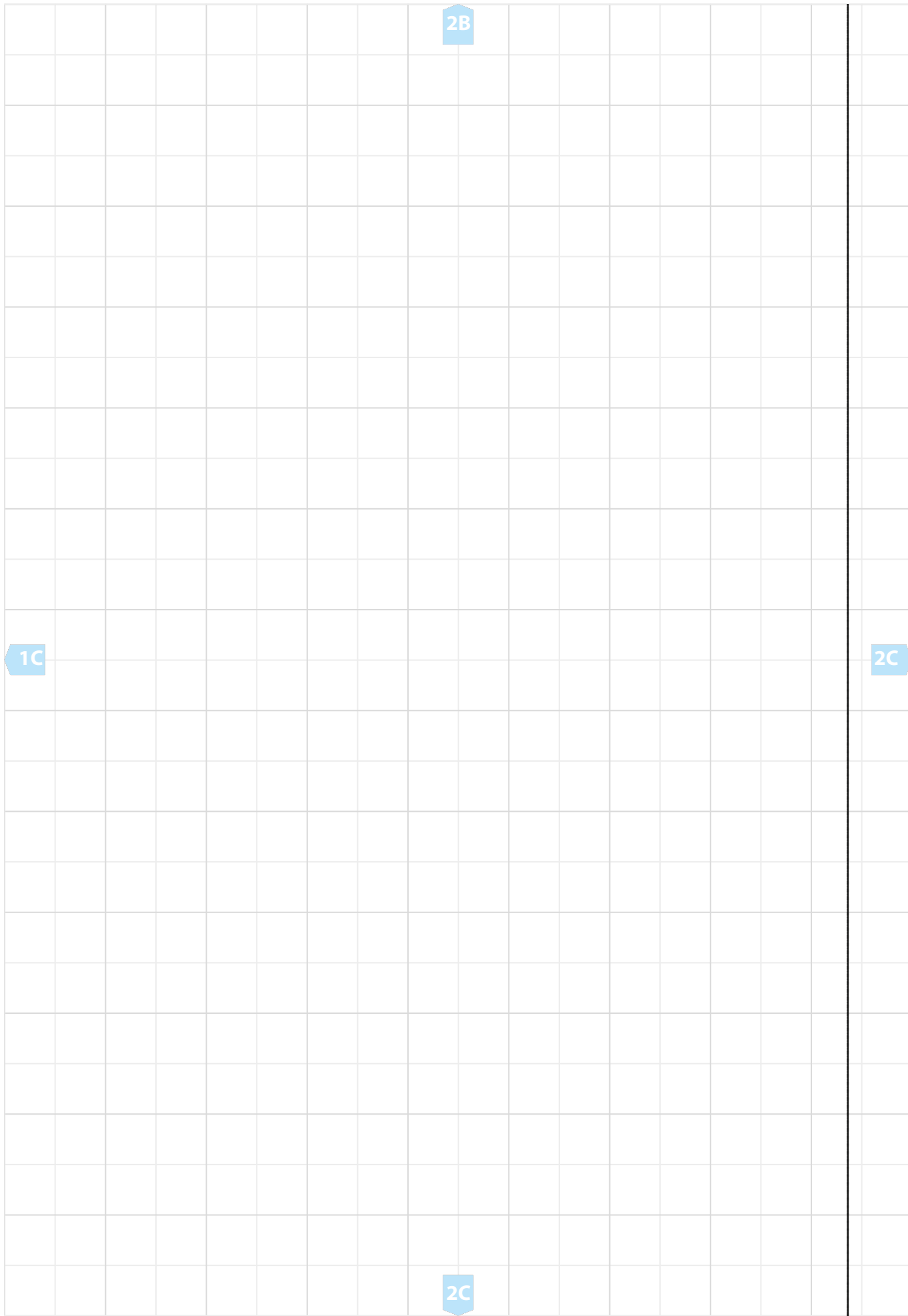

2B

1C

2C

2C

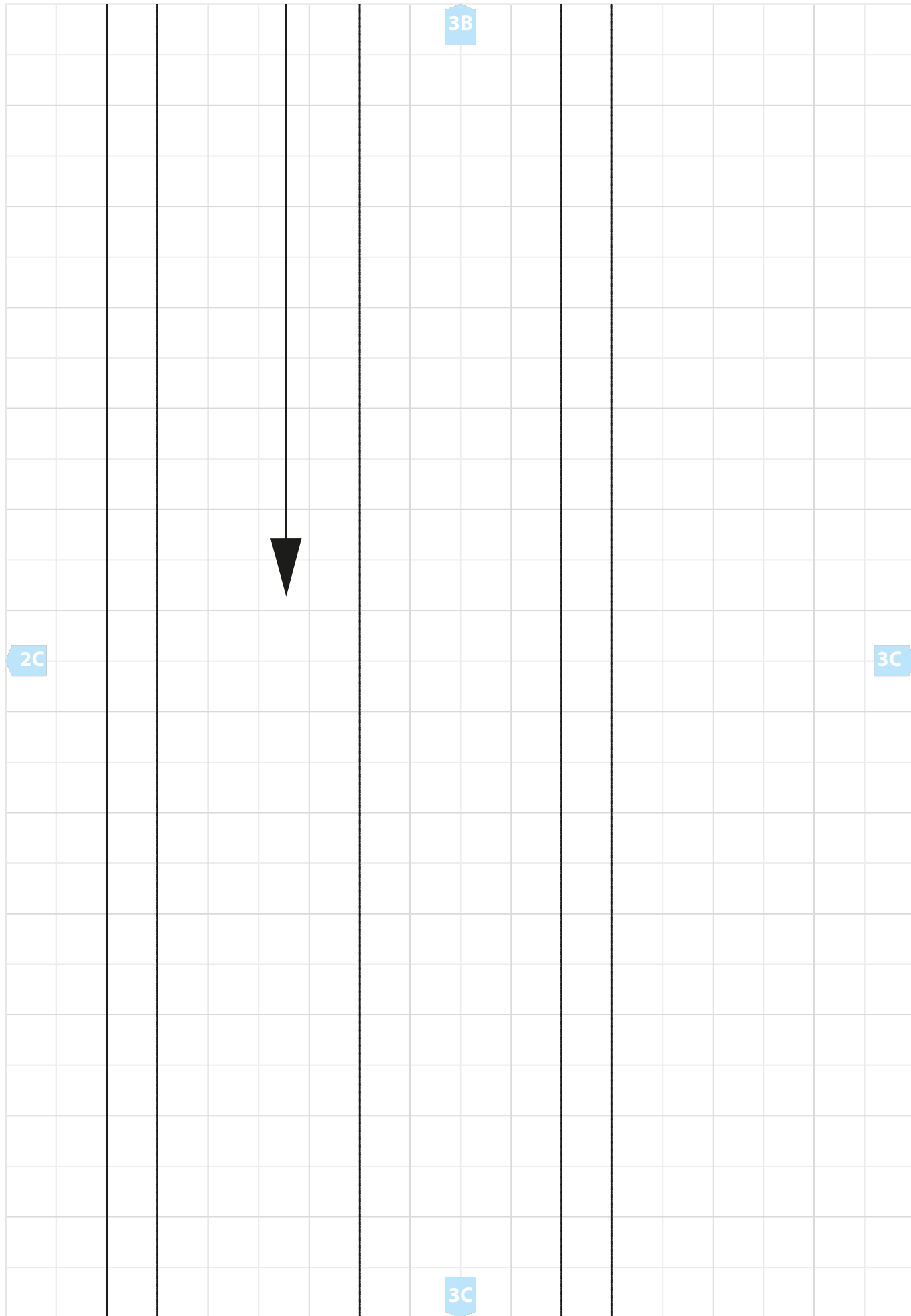

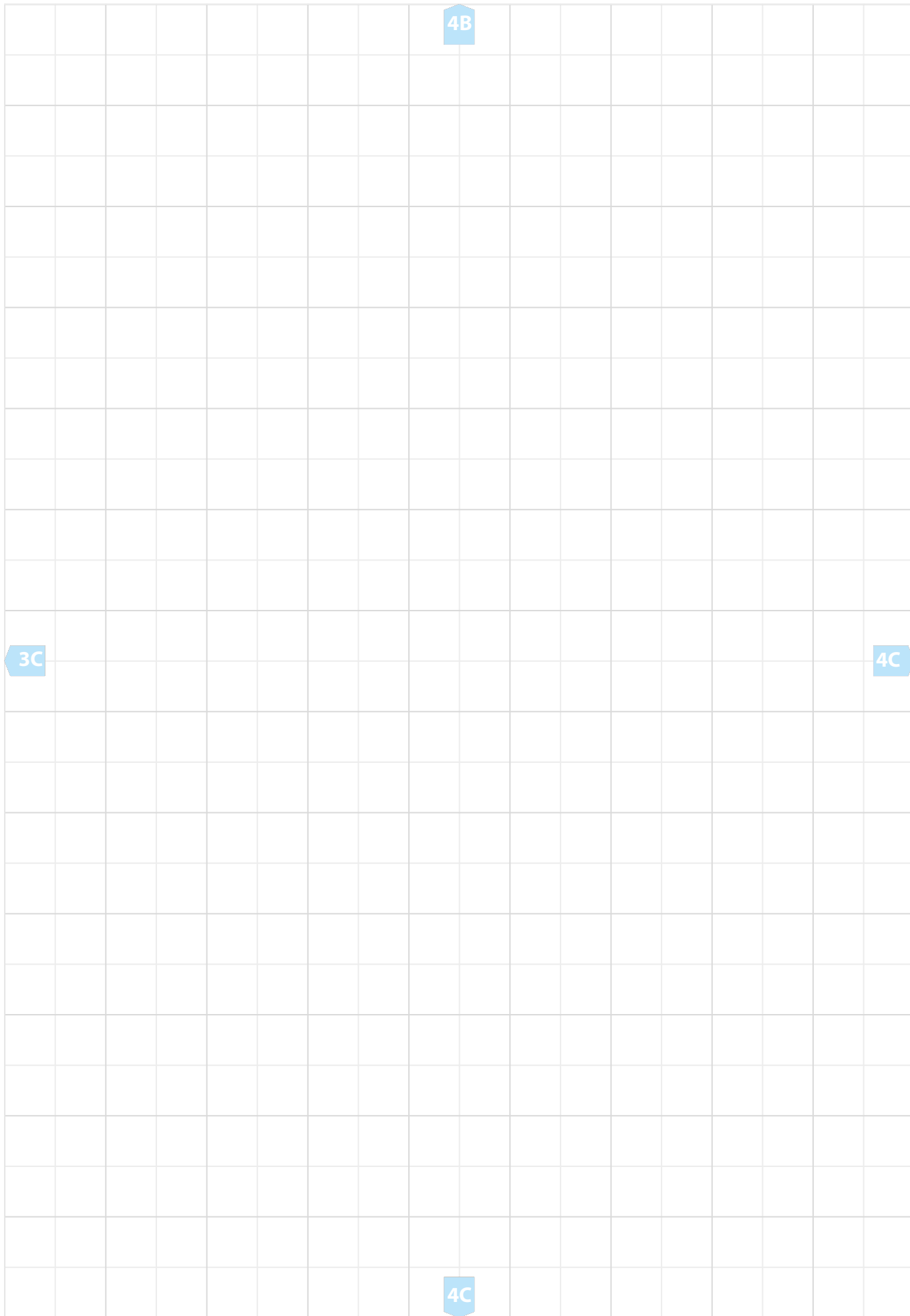

4B

3C

4C

4C

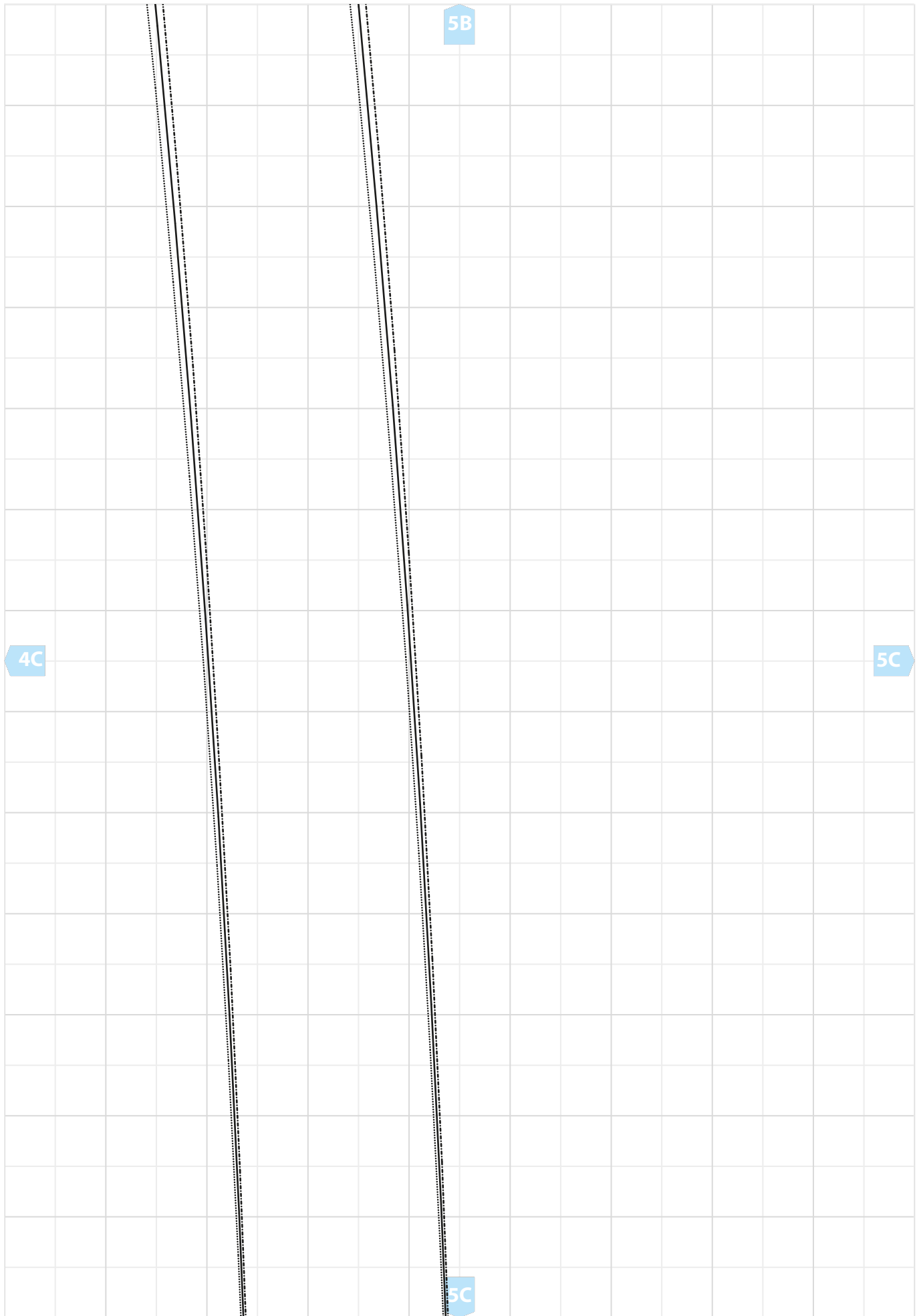

5B

4C

5C

5C

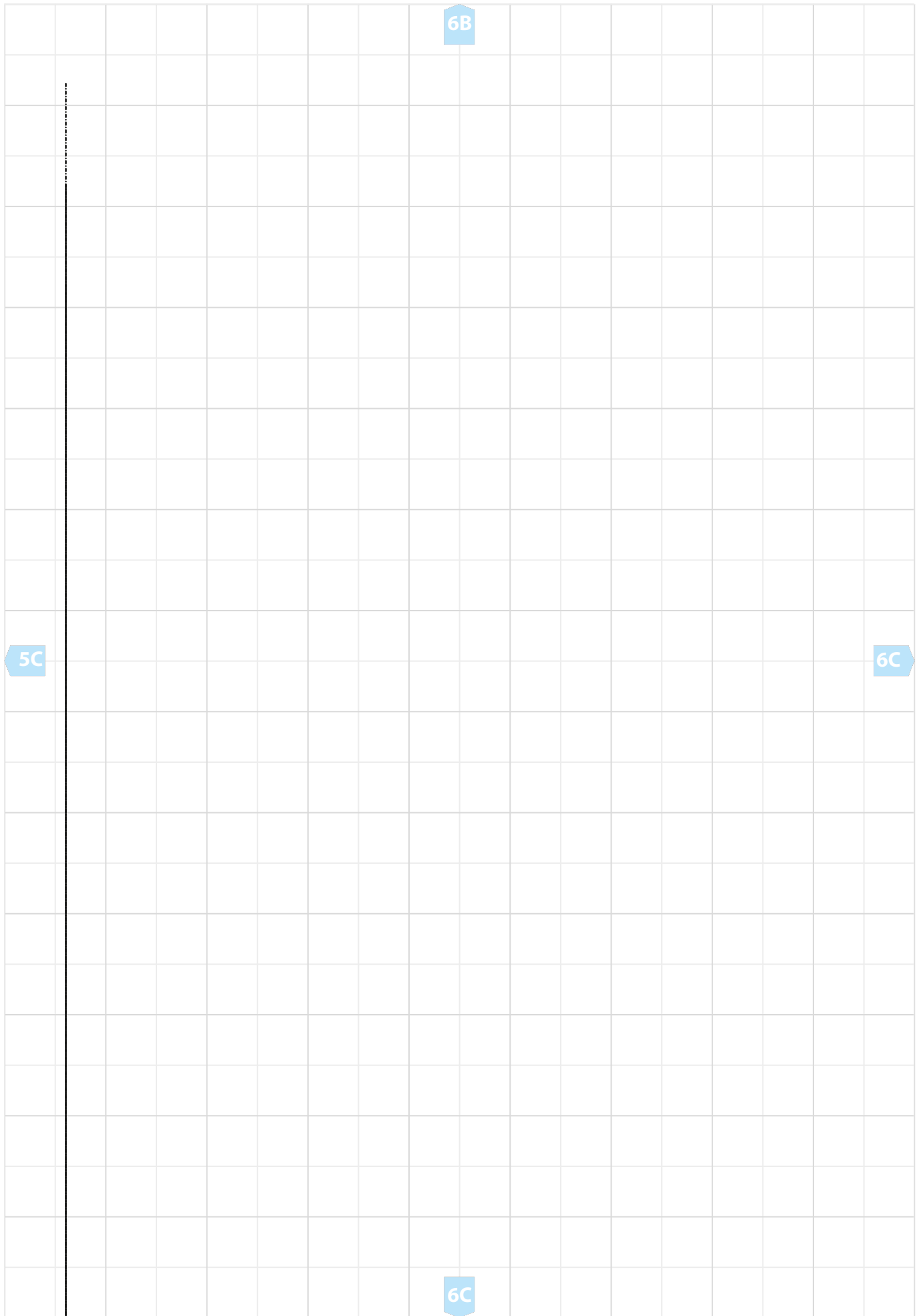

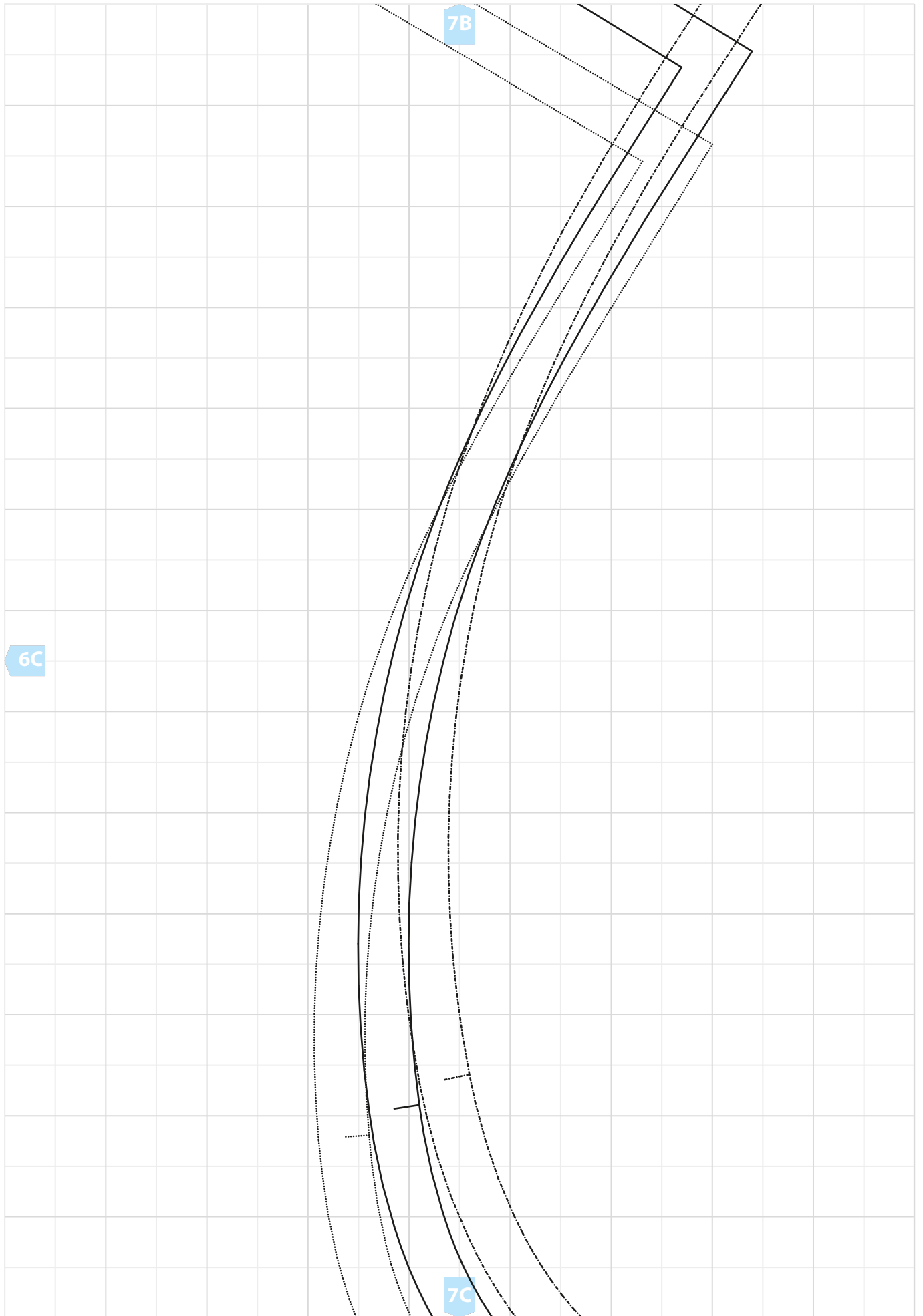

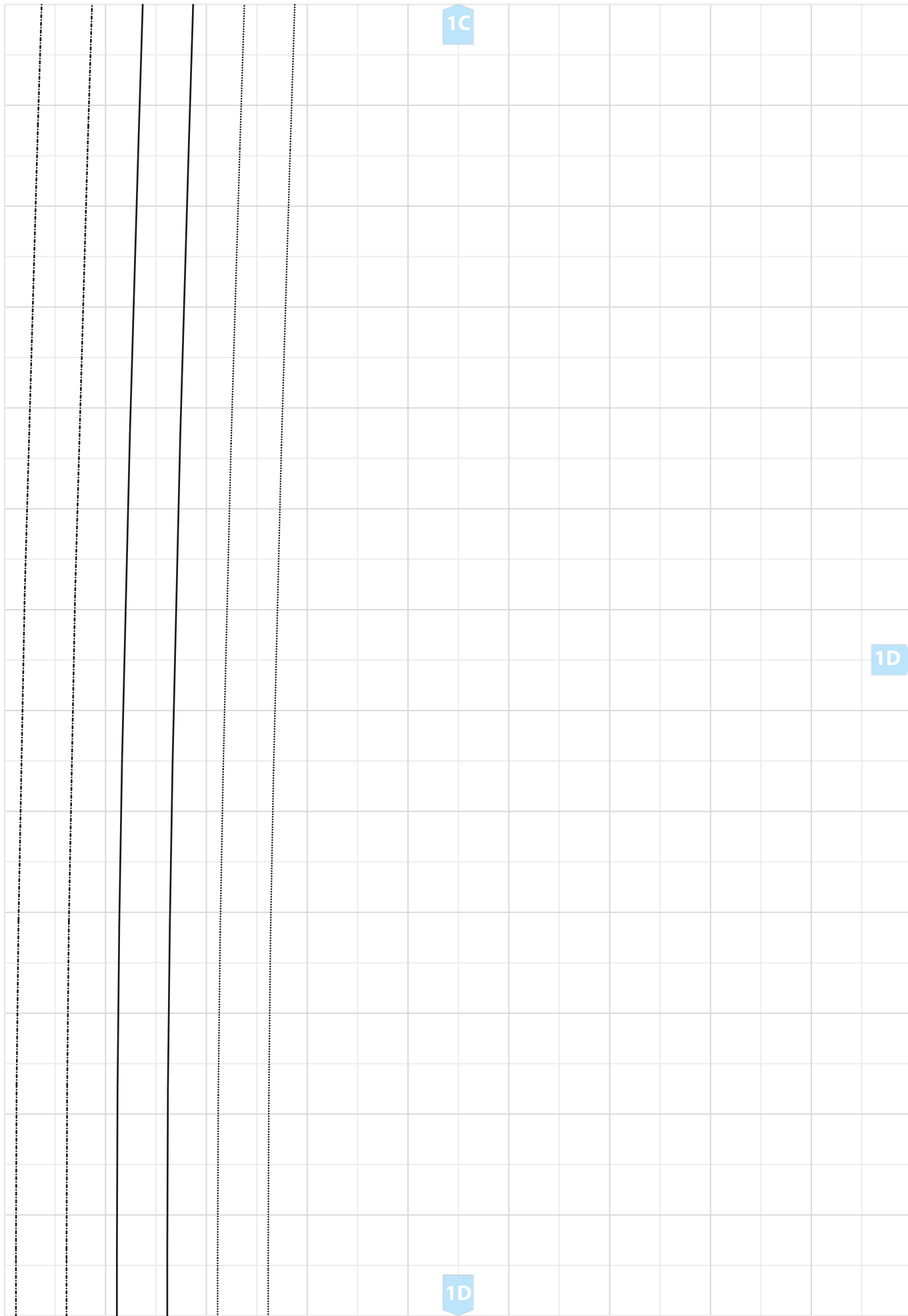

1C

1D

1D

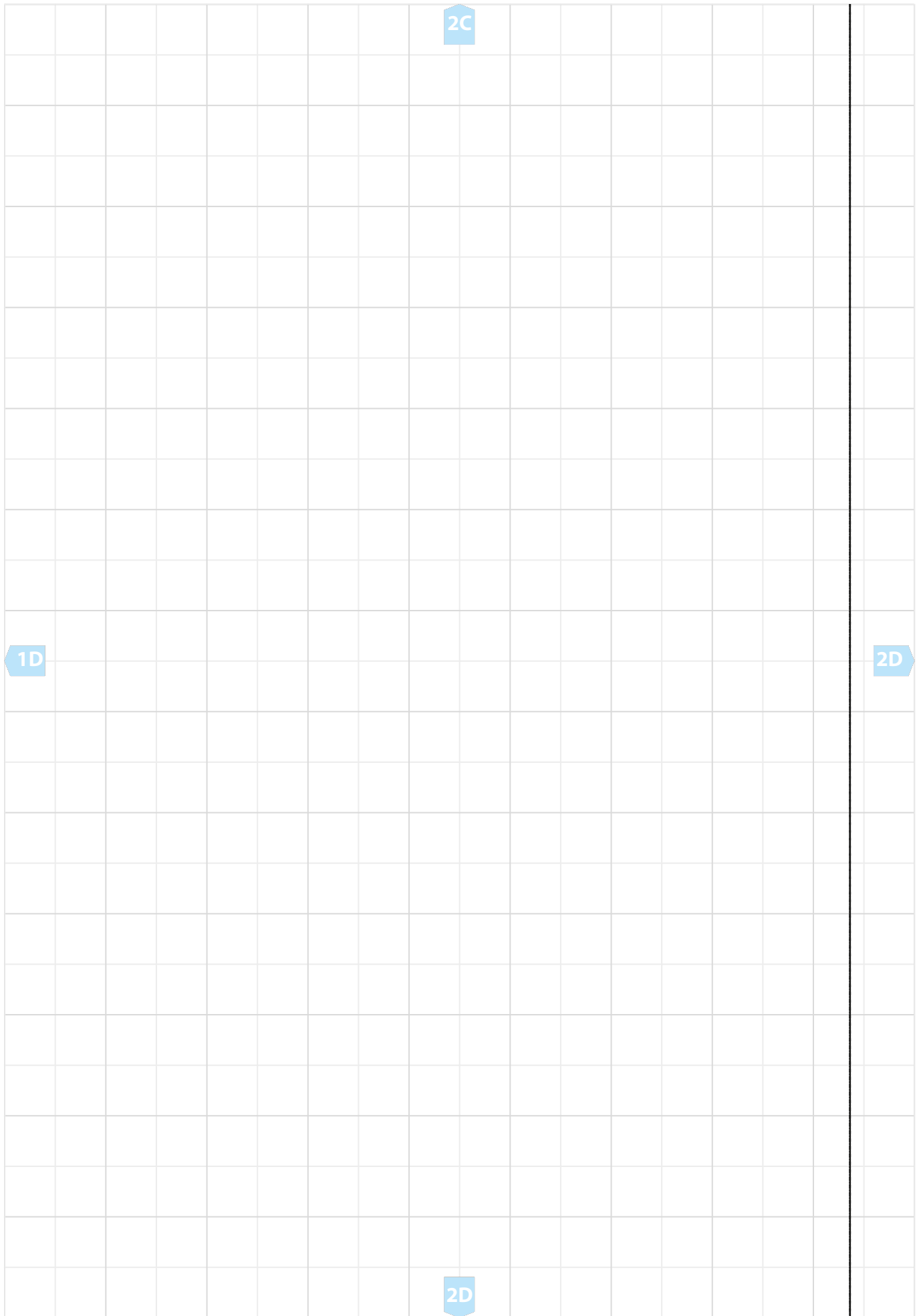

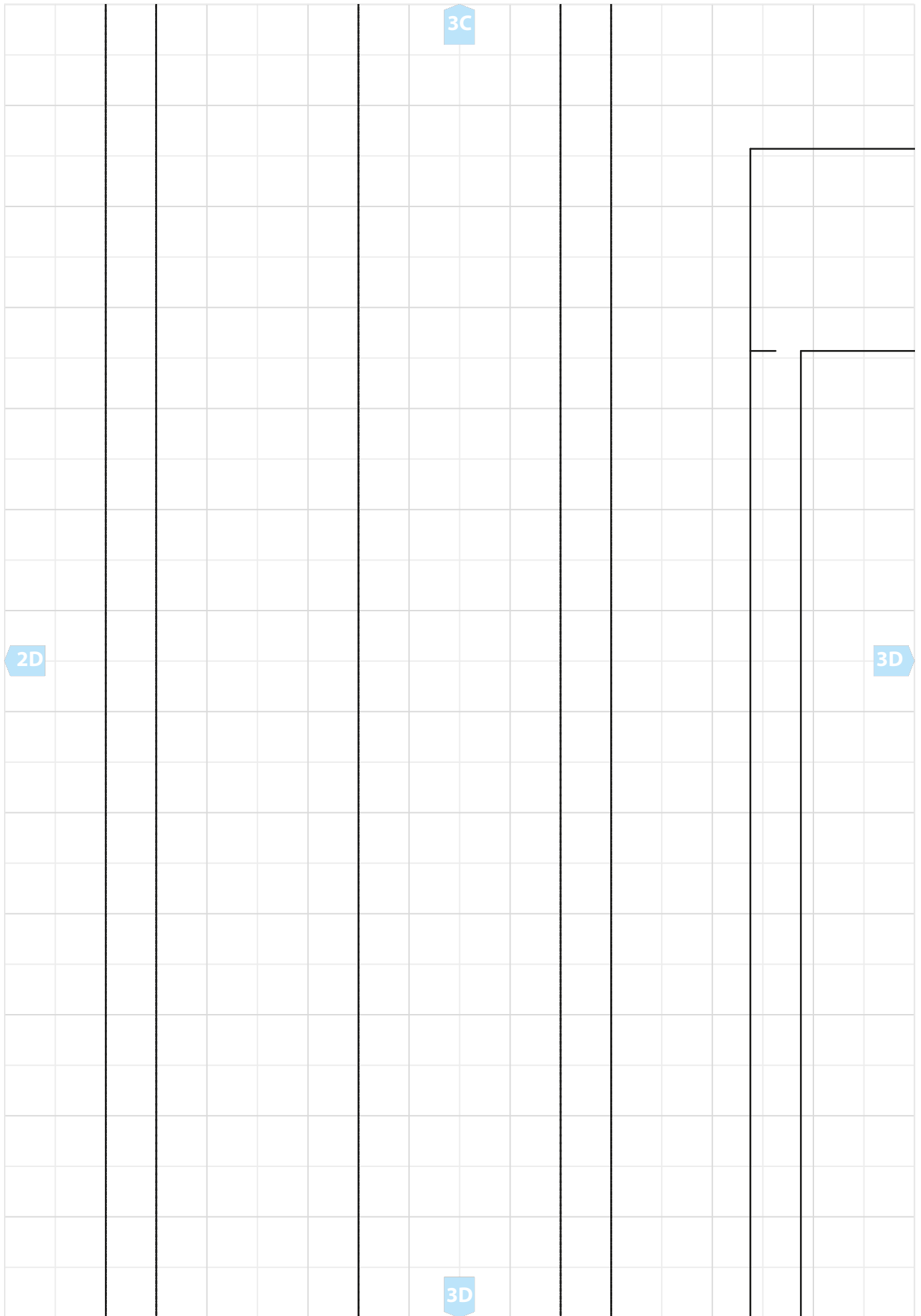

4C

UMBRUCH

FADENLAUF

3D

4D

aufgesetzter Taschenbeutel
2x Oberstoff

4D

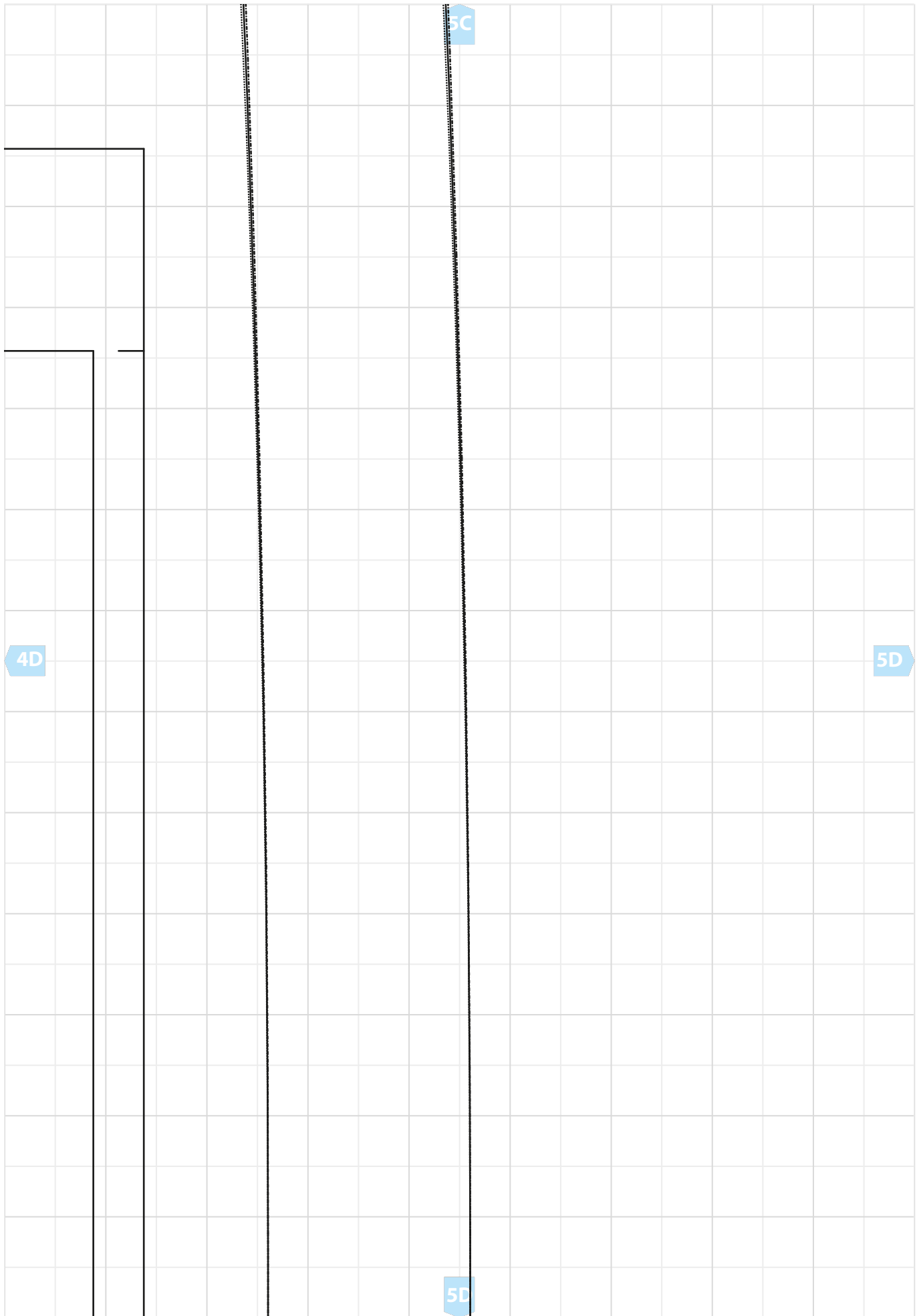

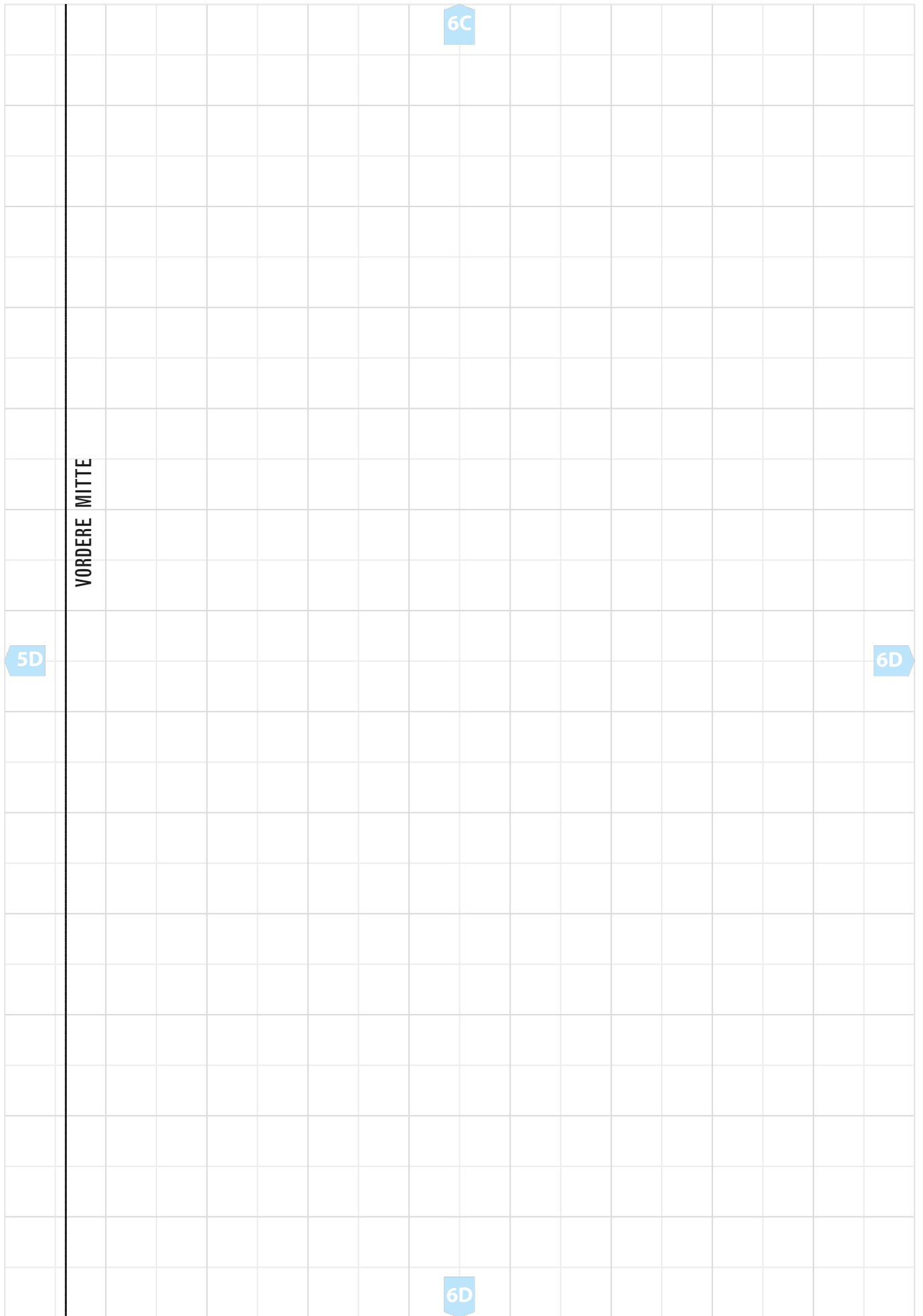

VORDERE MITTE

6C

5D

6D

6D

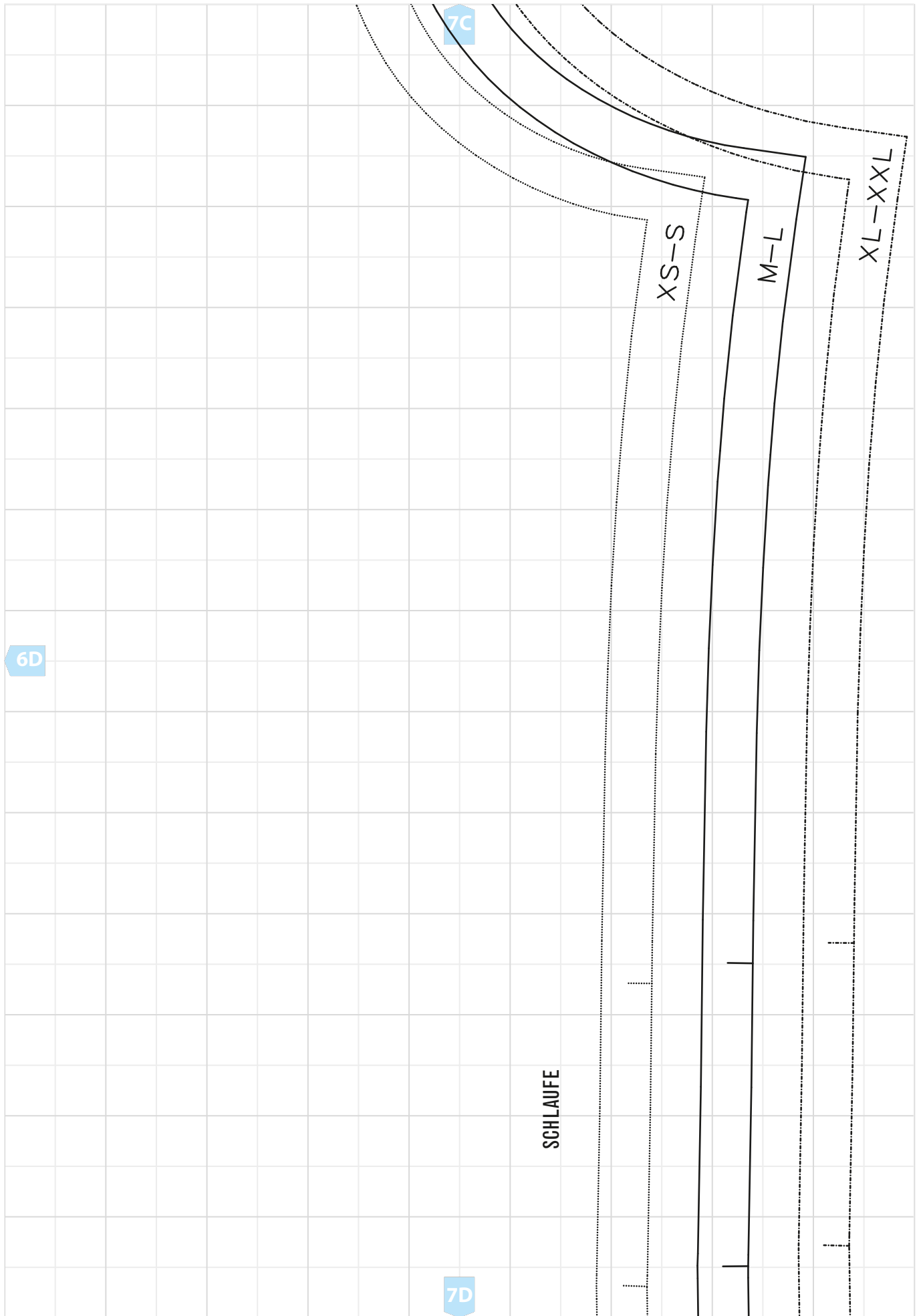

1D

1E

XL-XXL

M-L

XS-S

1E

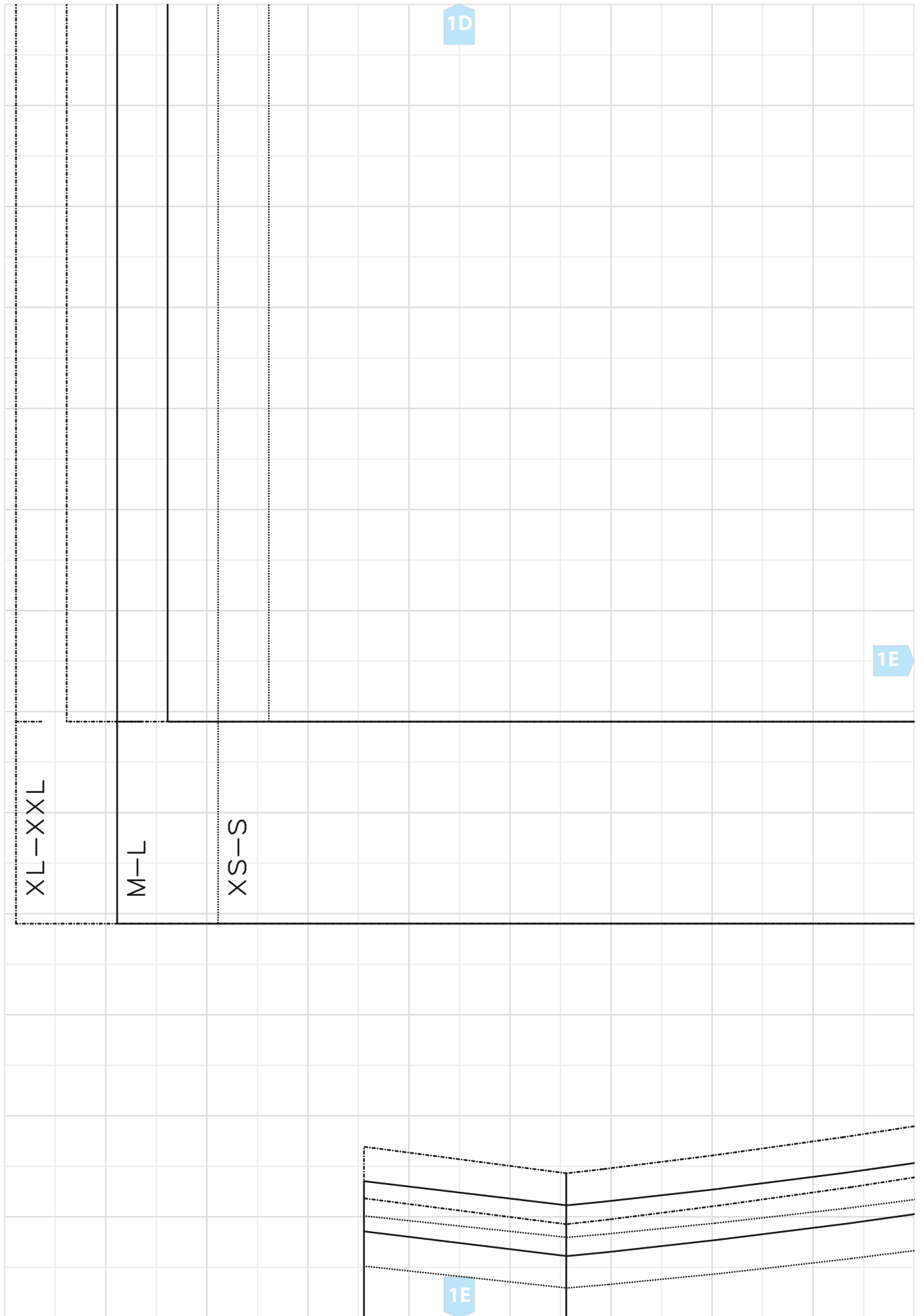

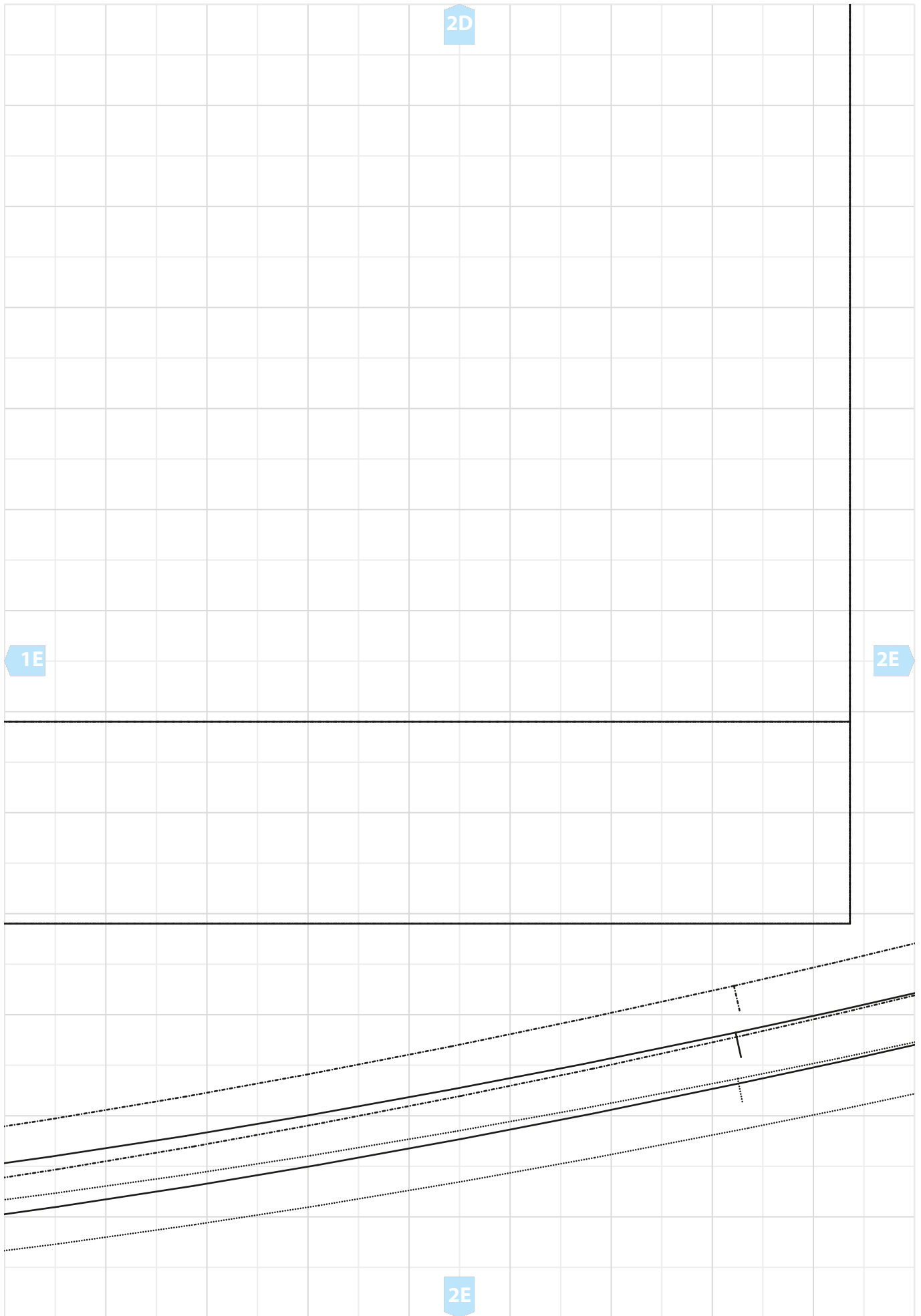

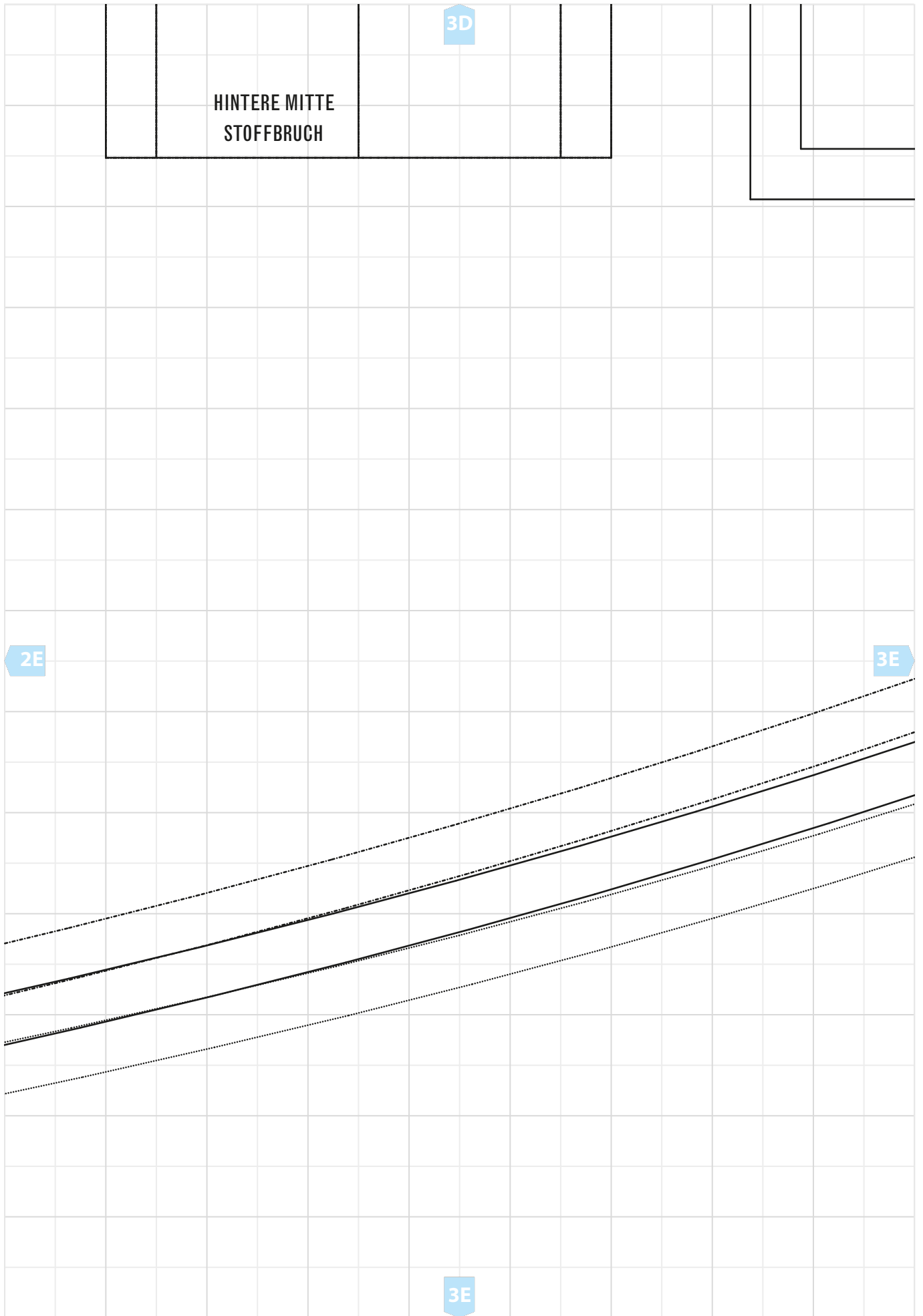

3D

HINTERE MITTE
STOFFBRUCH

2E

3E

3E



4D

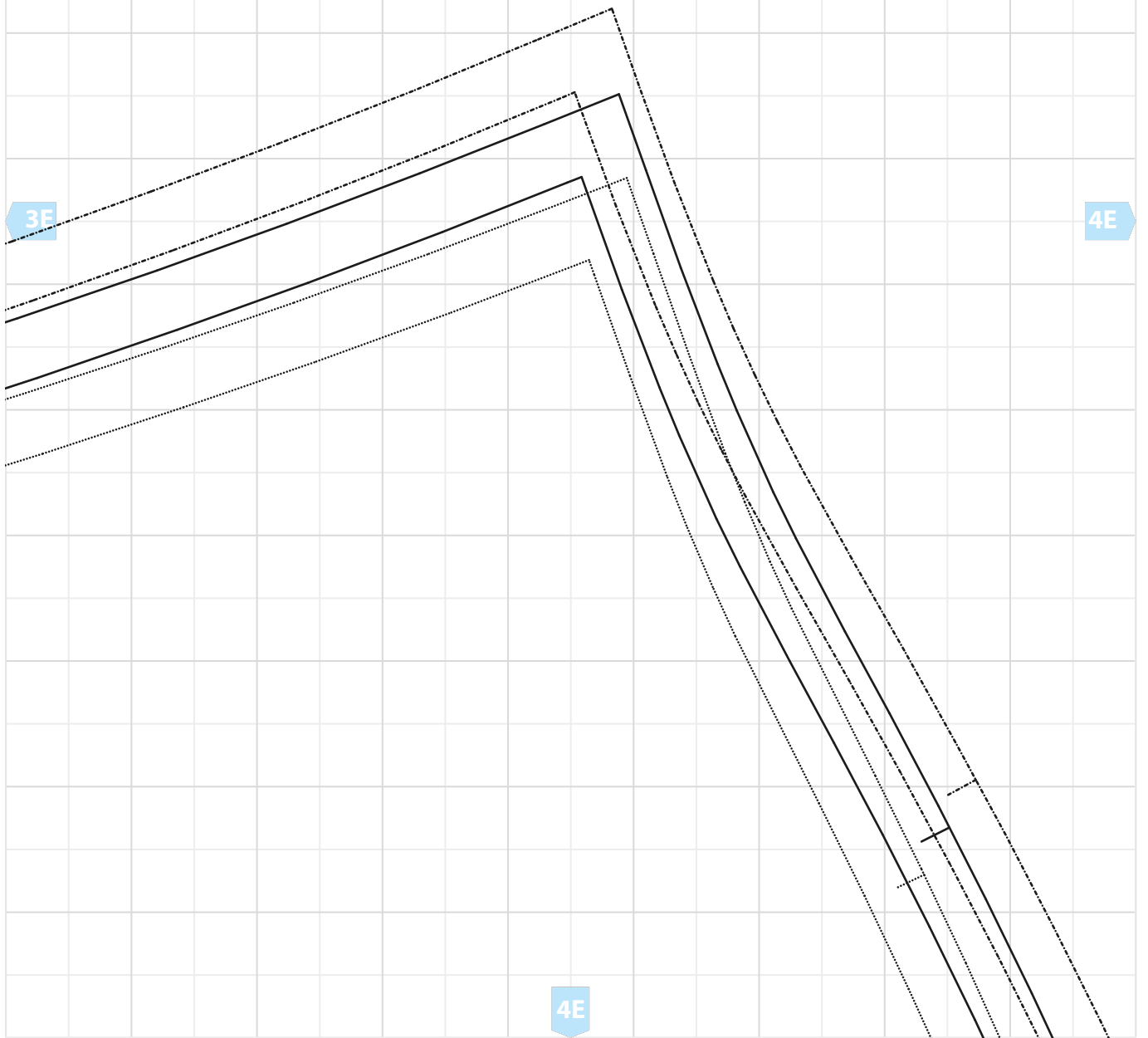
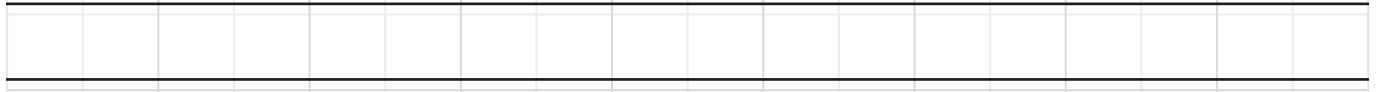

3E

4E

4E

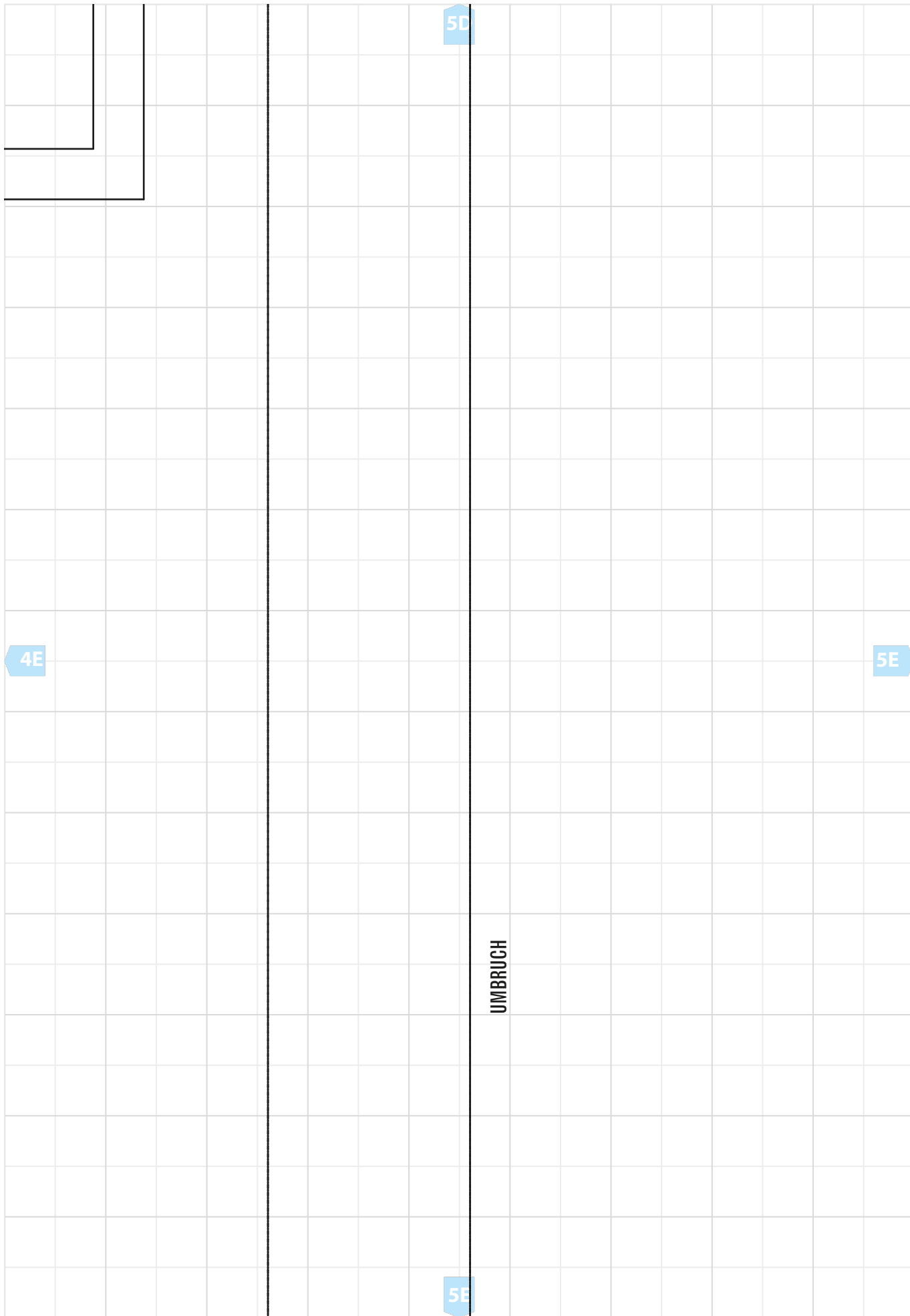

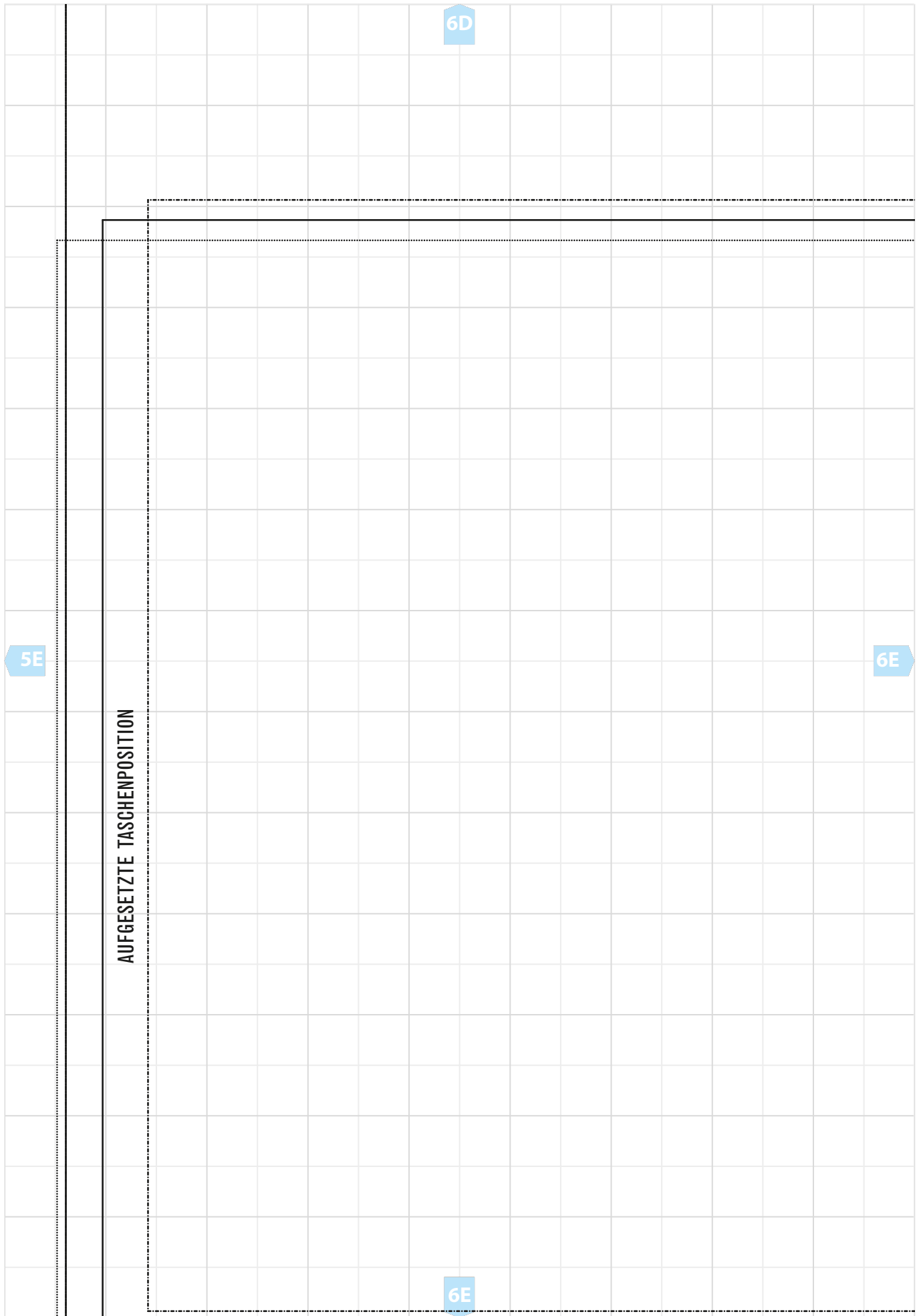

7D

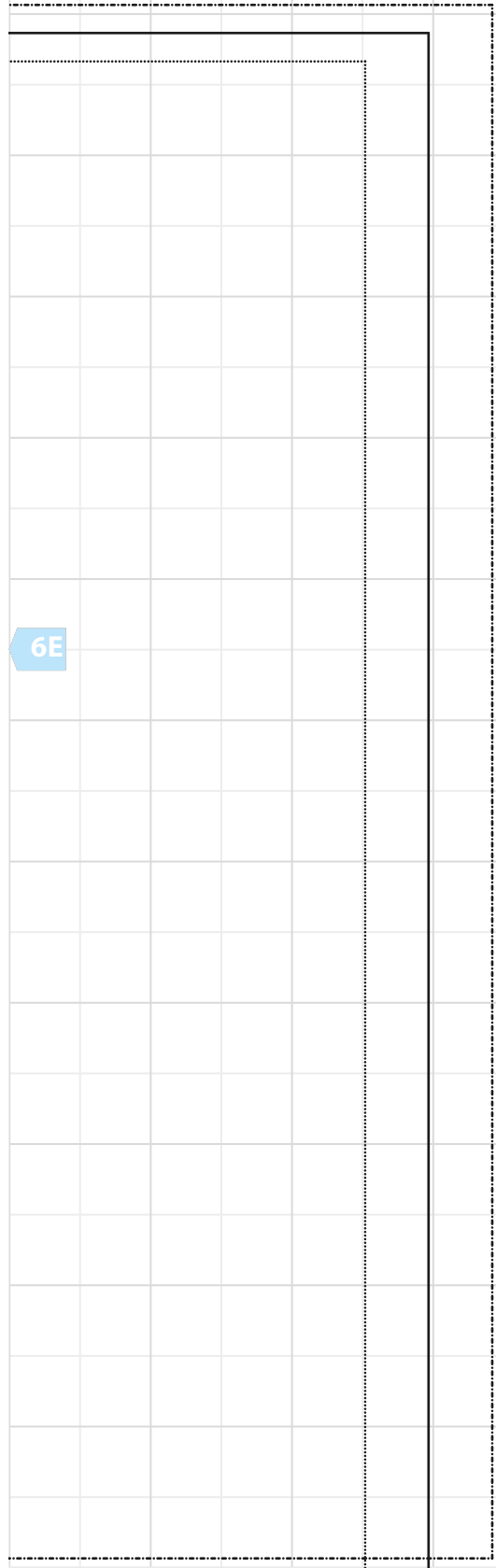

TASCHEINGRIFF

7E

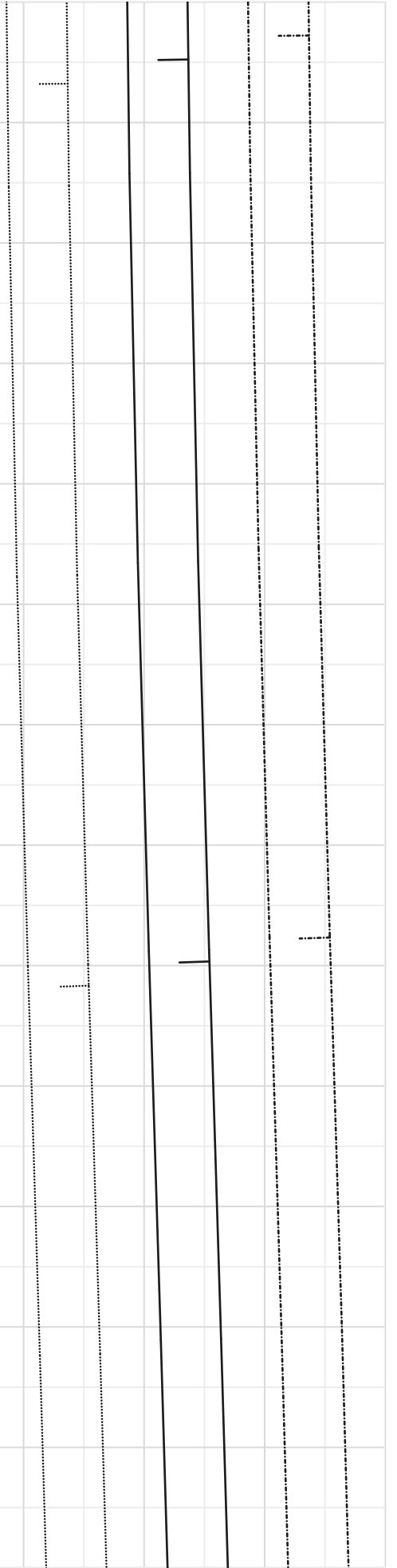

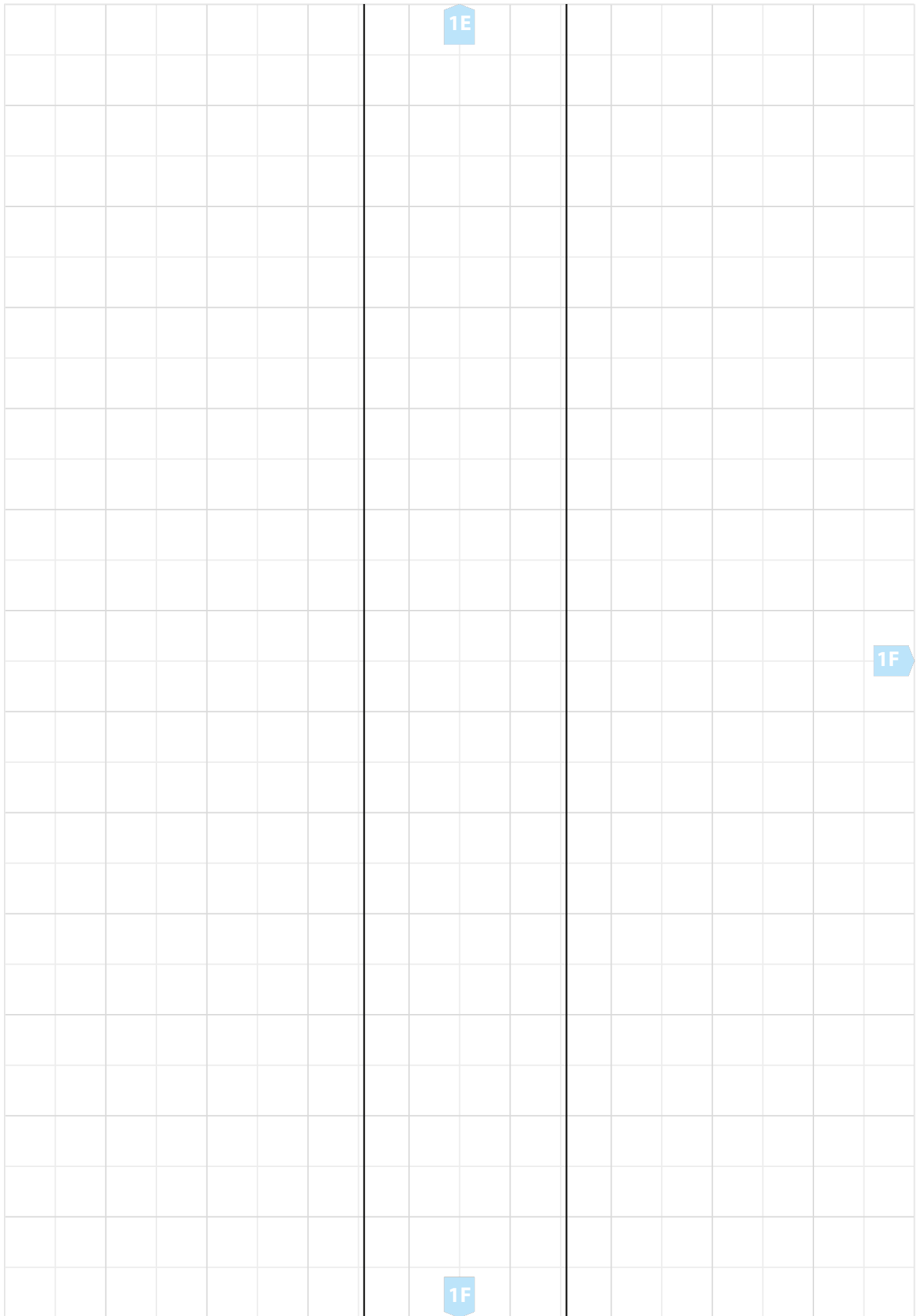

1E

1F

1F

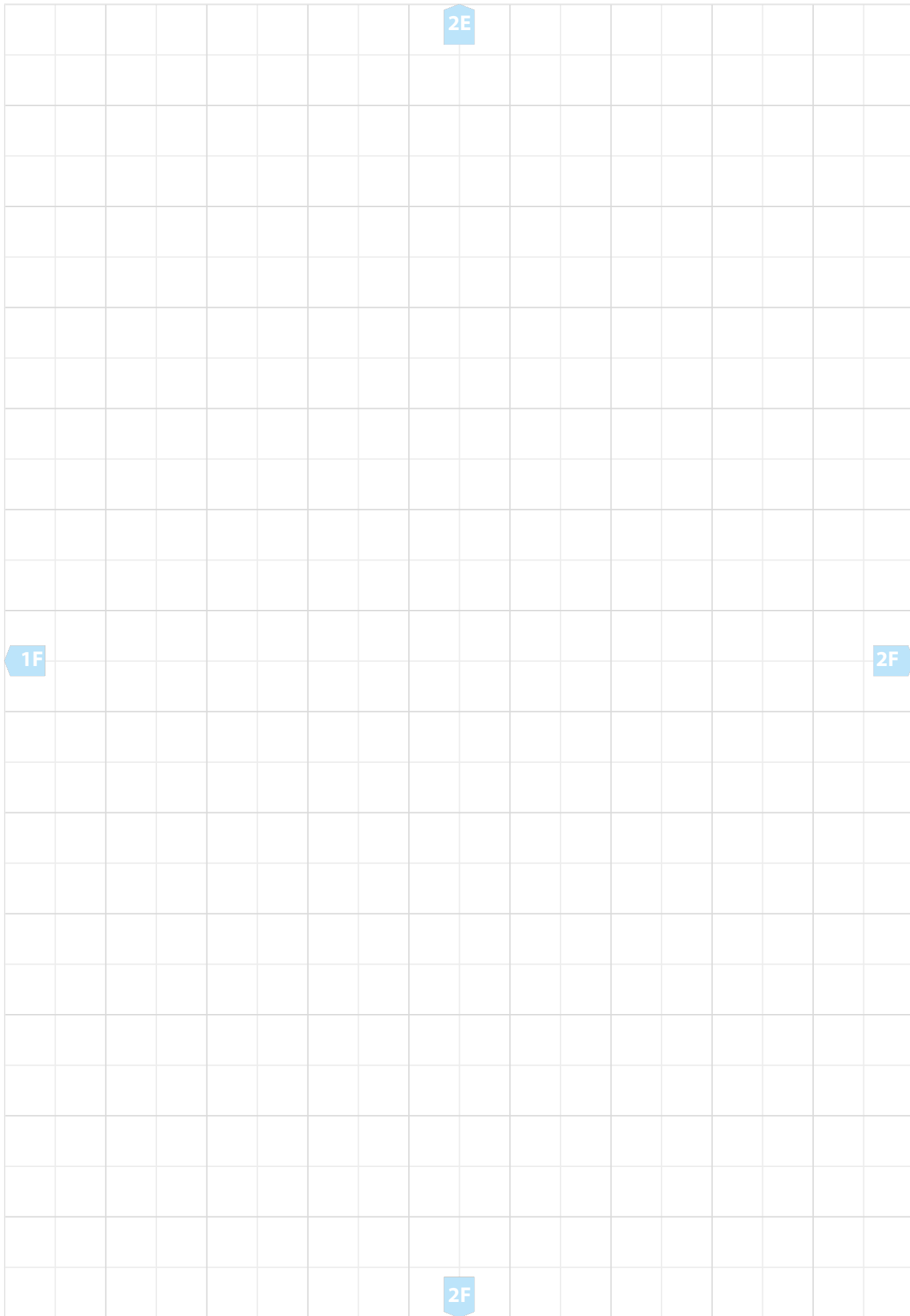

3E

2F

3F

Ärmel
2x Oberstoff

3F

4E

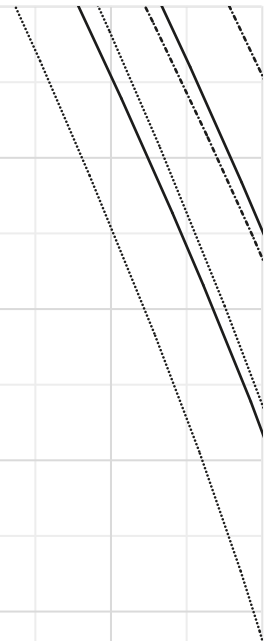

3F

4F

4F

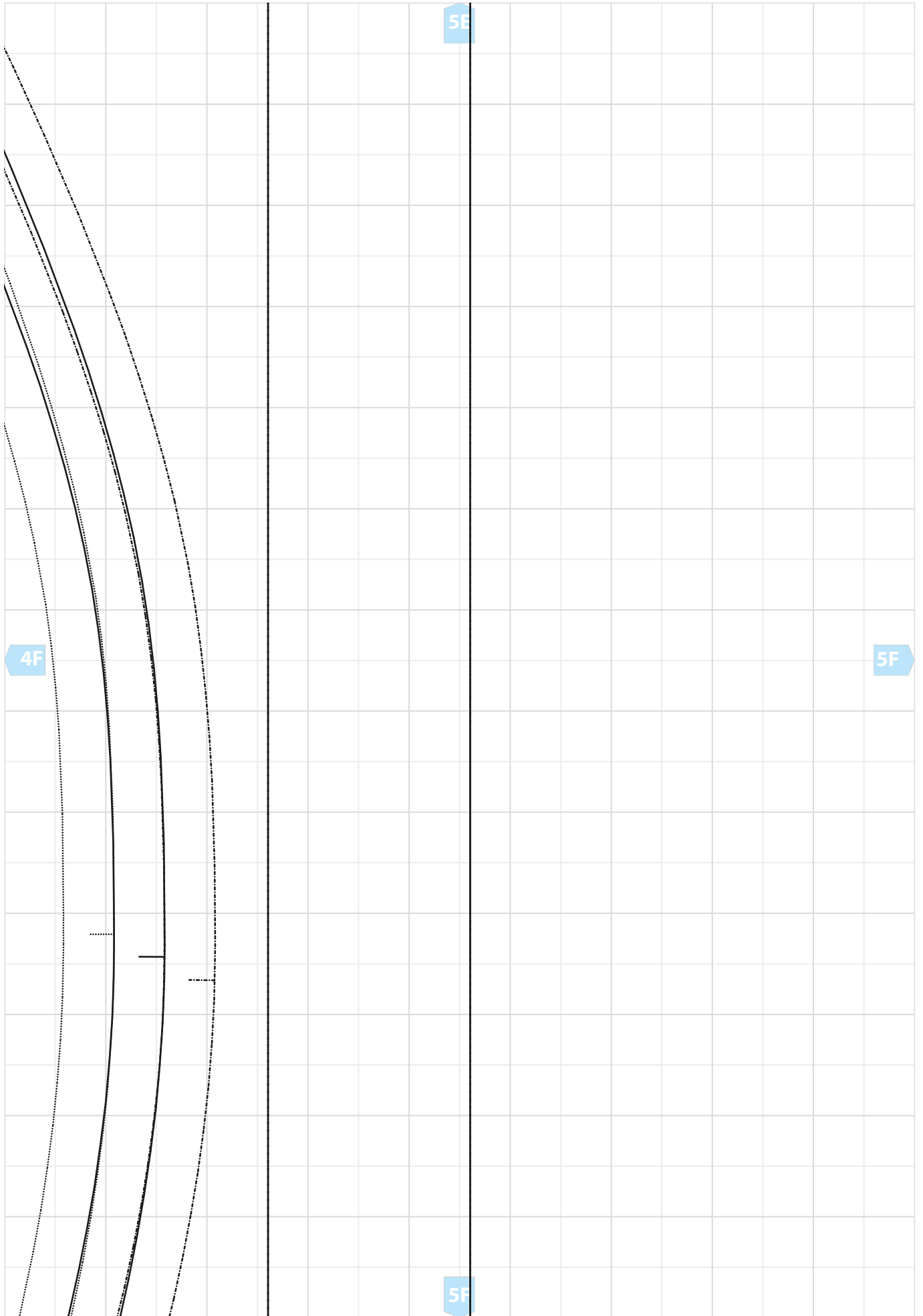

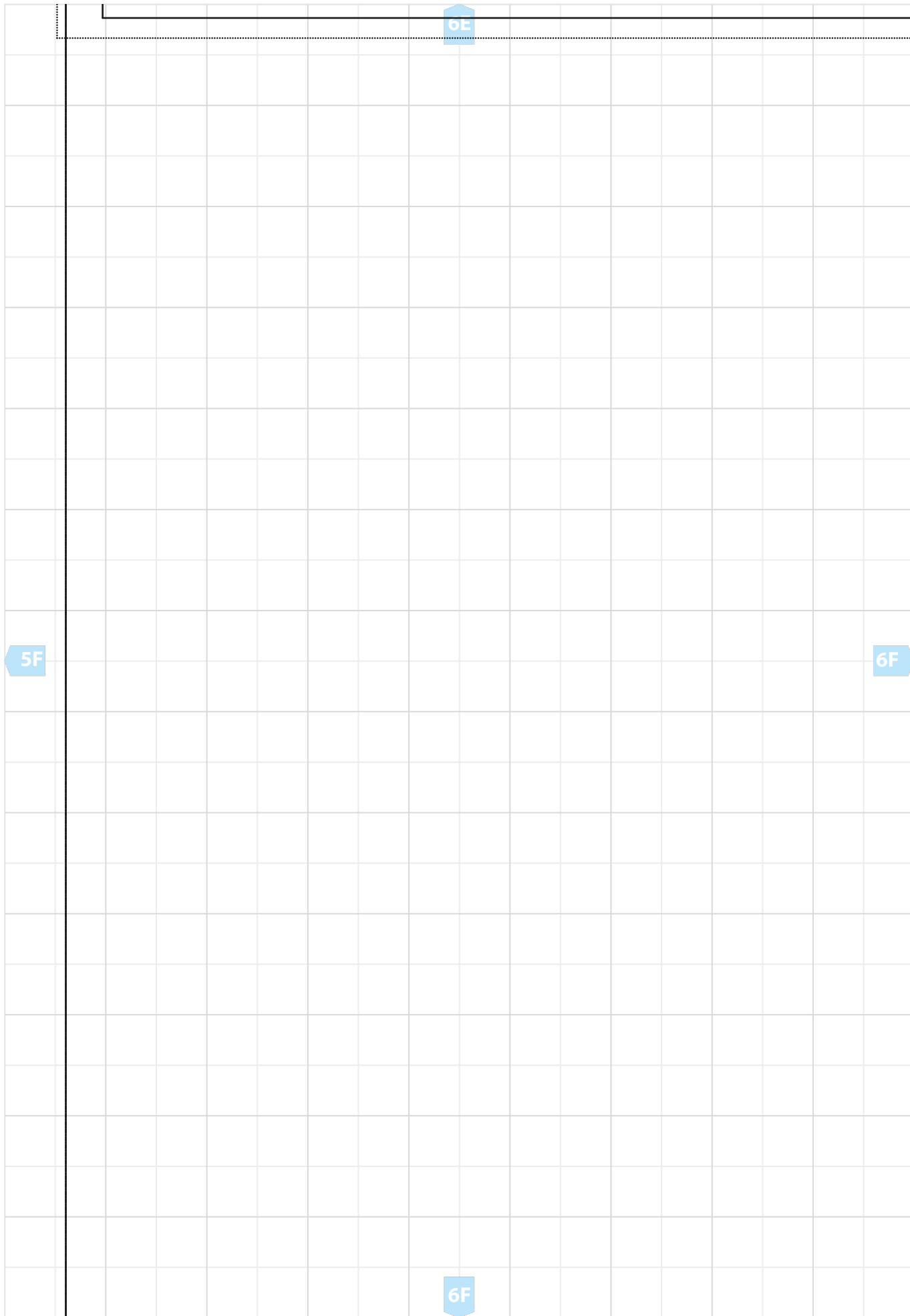

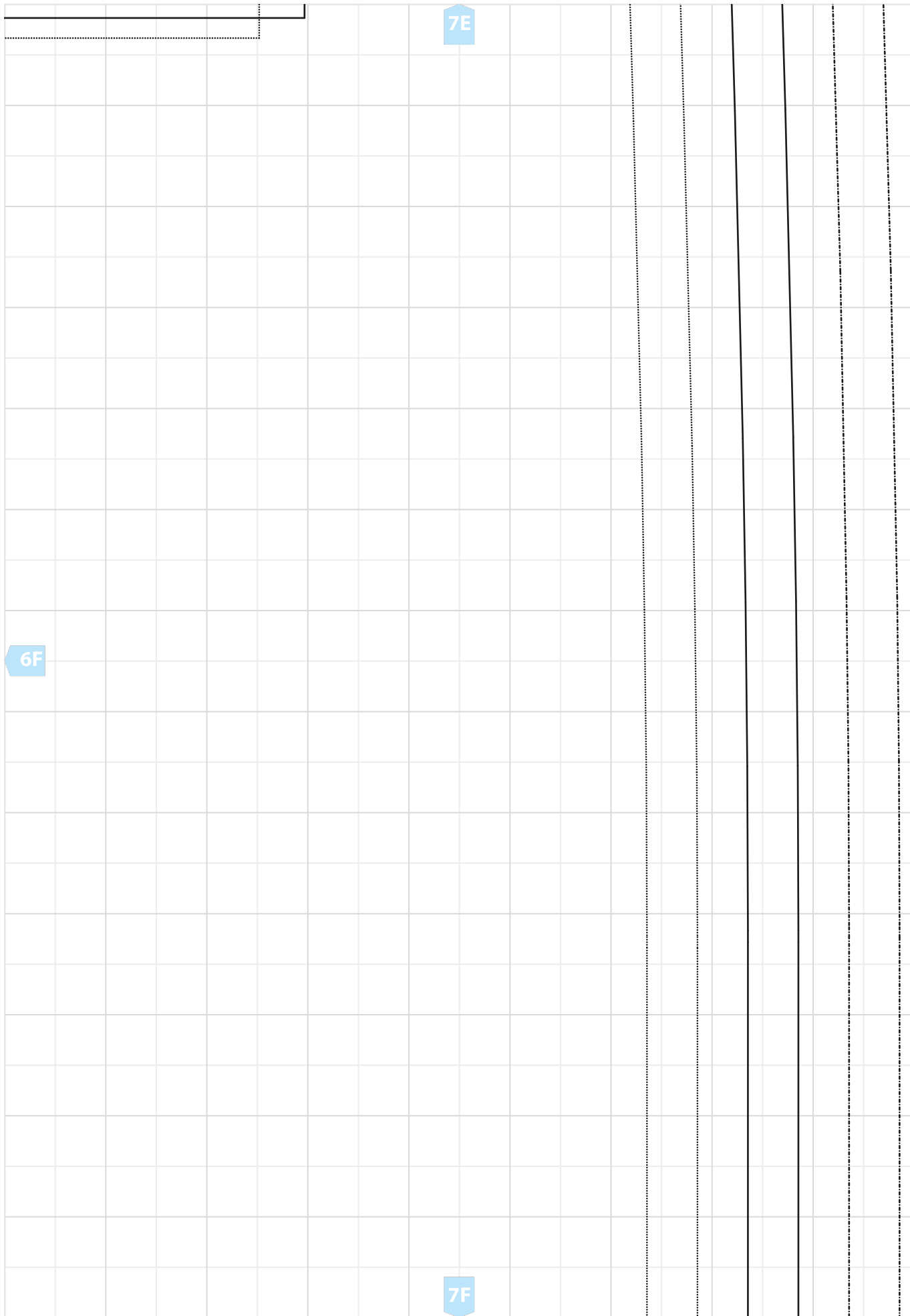

7E

6F

7F

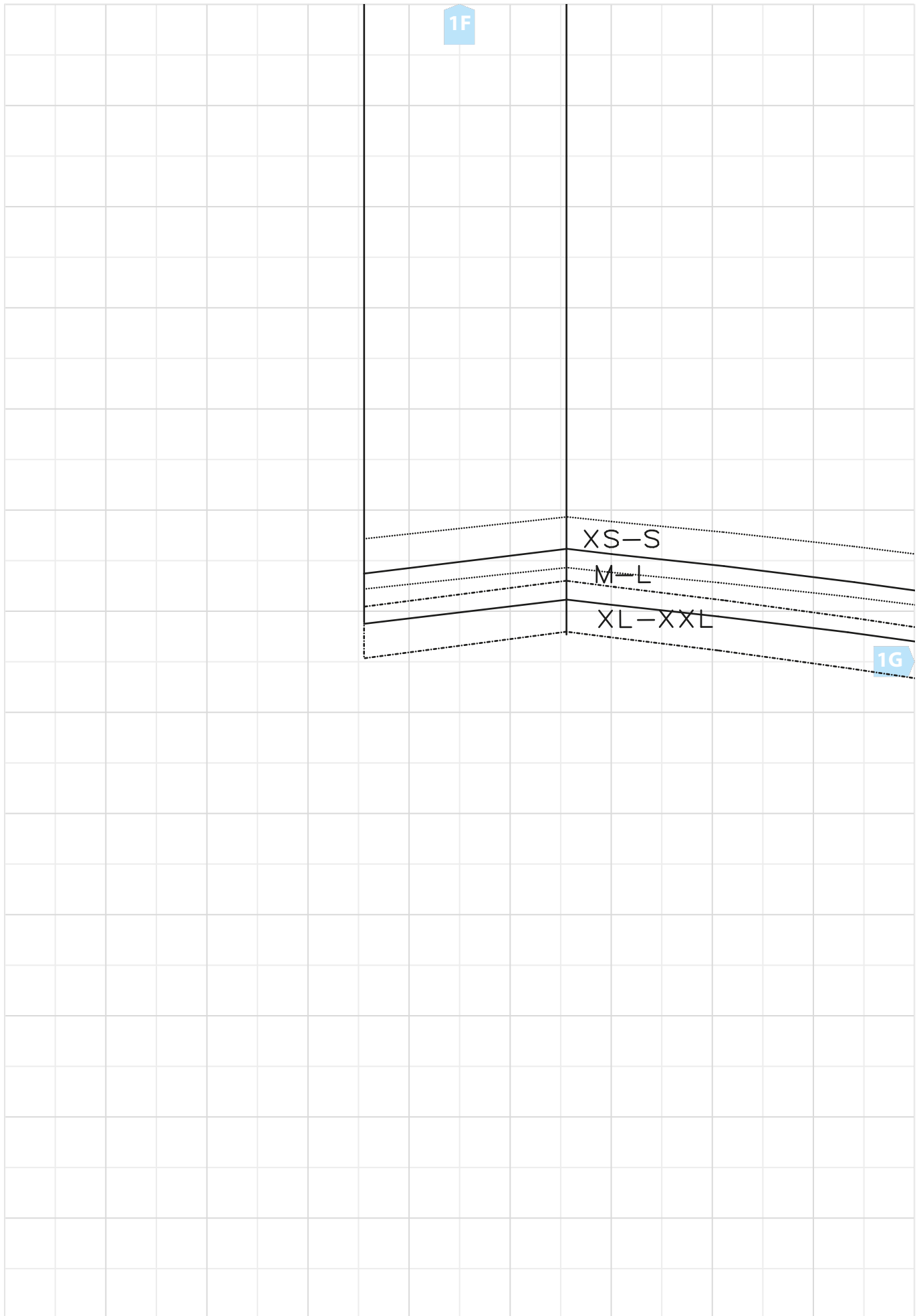

1F

XS-S

M-L

XL-XXL

1G

2F

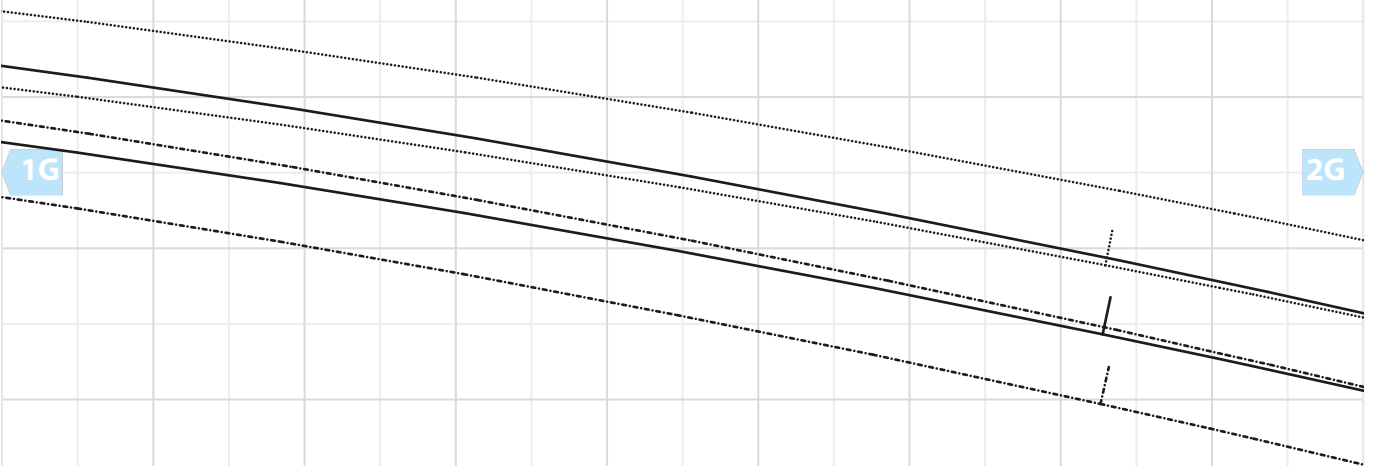

3F

Fadenlauf

2G

3G

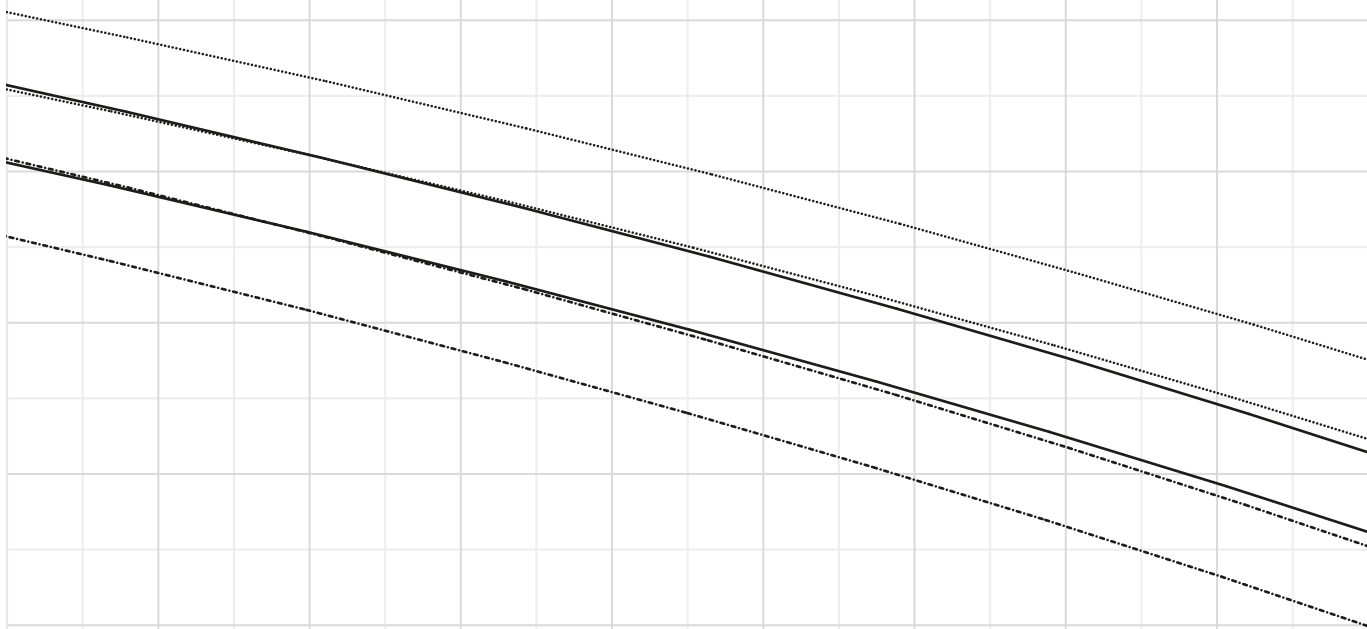

4F

3G

4G

XS-S

M-L

XL-XXL

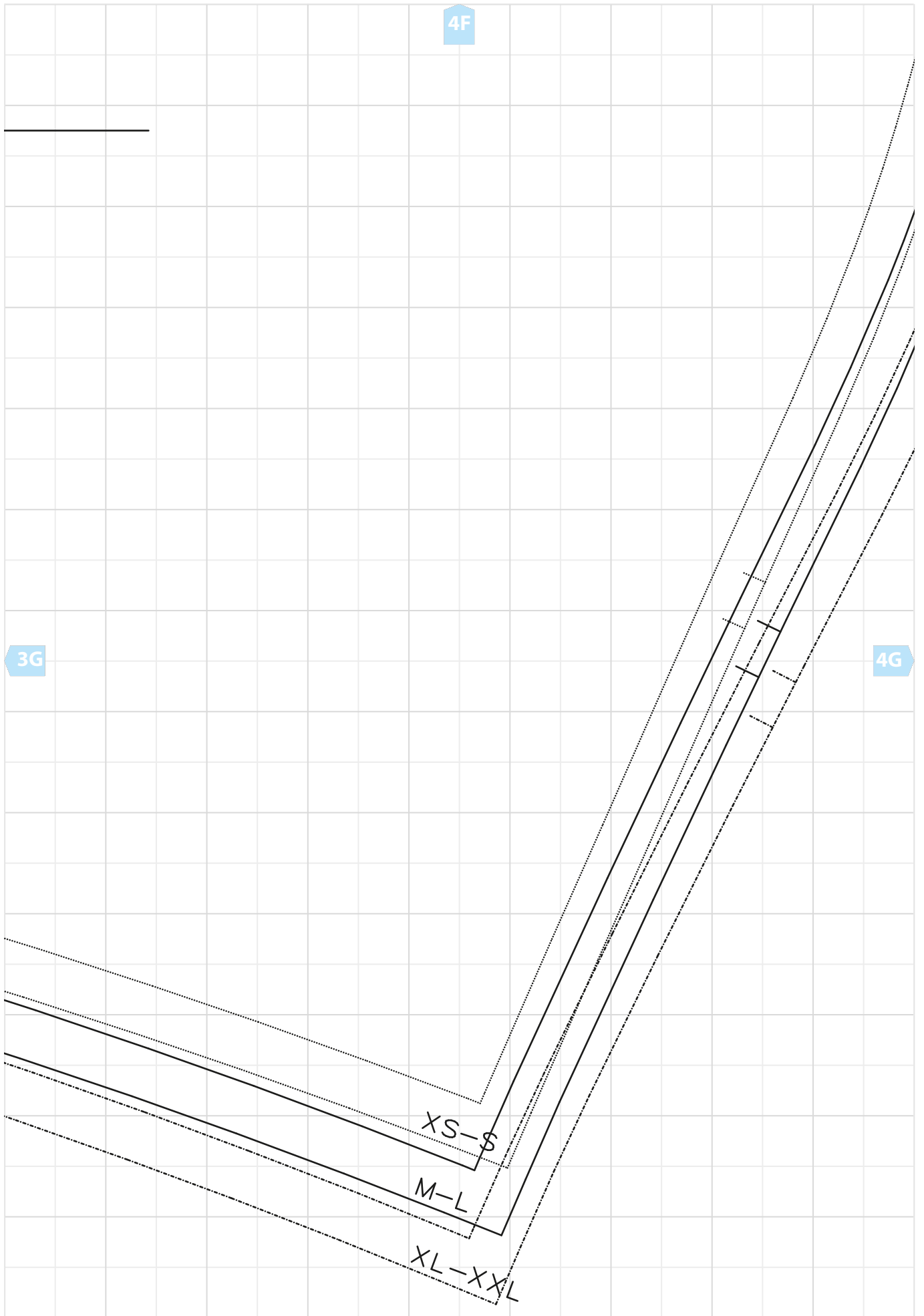

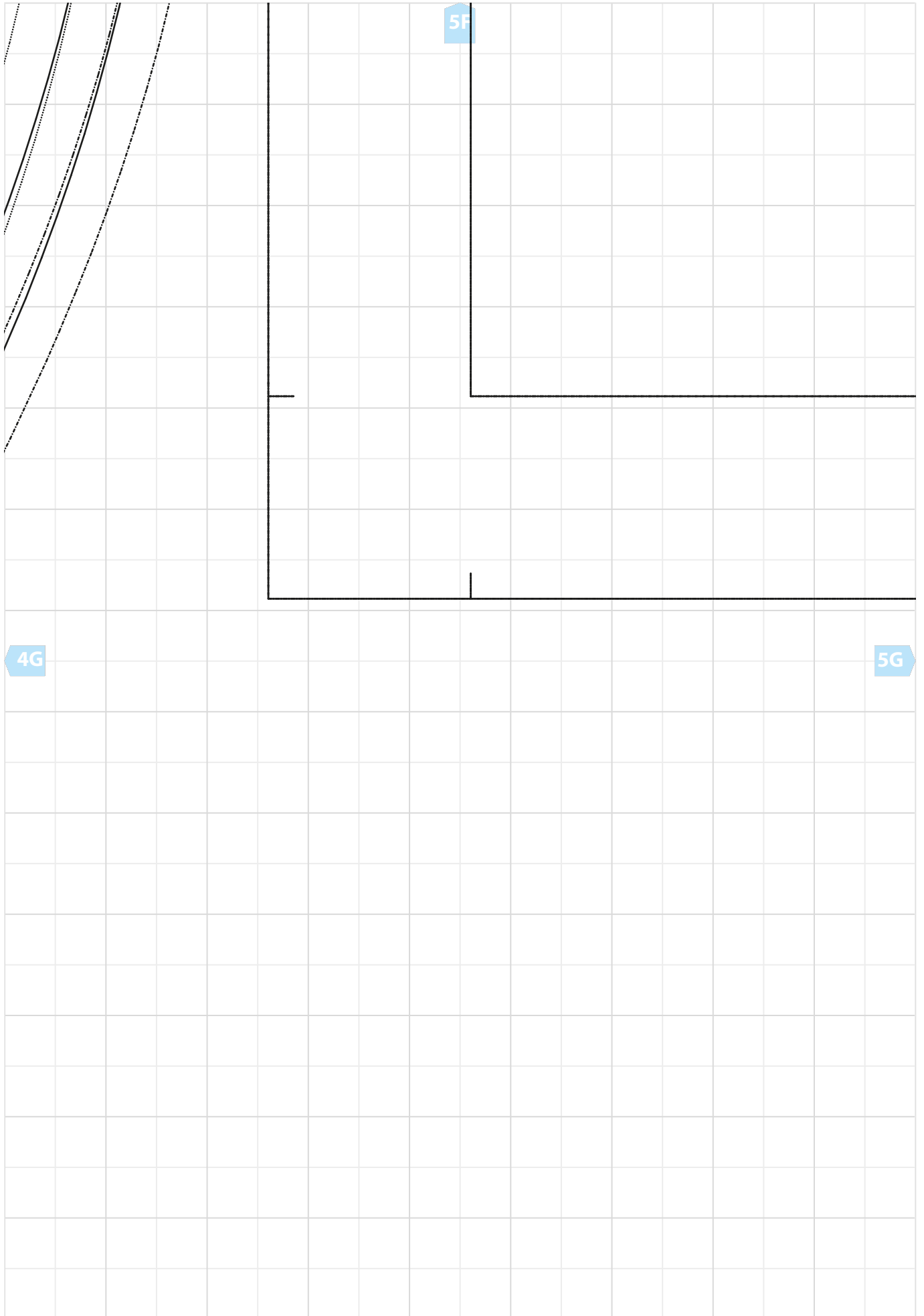

6F

5G

6G

7F

XS-S

M-L

XL-XXL

6G