

Seiten insgesamt:	36
Nr. 1 Vorderteil	6
Nr. 2 Rückteil	20
Nr. 3 Ärmelmanschette	2
Nr. 4 Halslochbündchen	4
Nr. 5 Saumbund	4

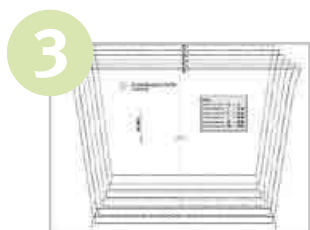

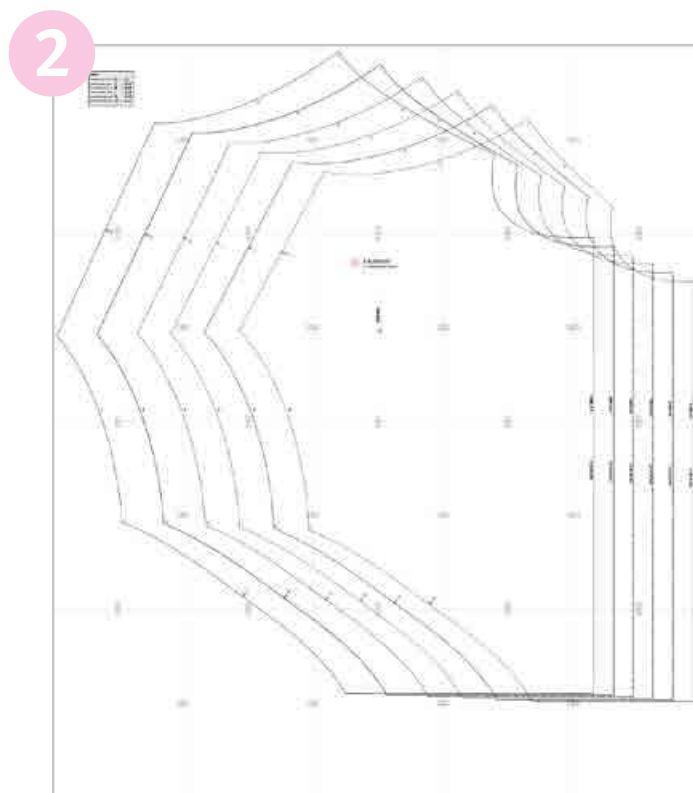

Größen	
.....	XS = 32
-----	S = 34-36
.....	M = 38-40
-----	L = 42-44
-----	XL = 46-48
.....	XXL = 50-52

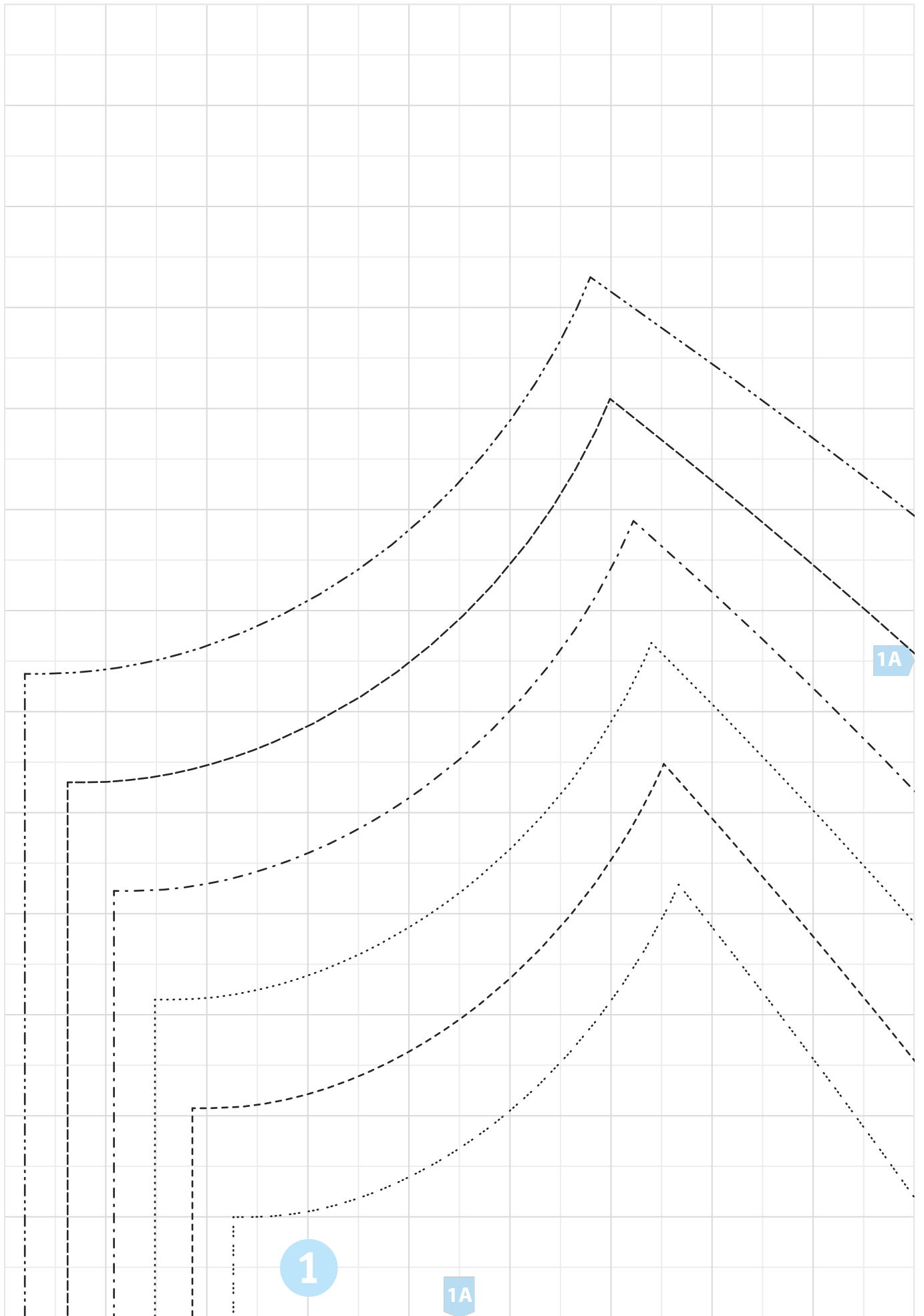
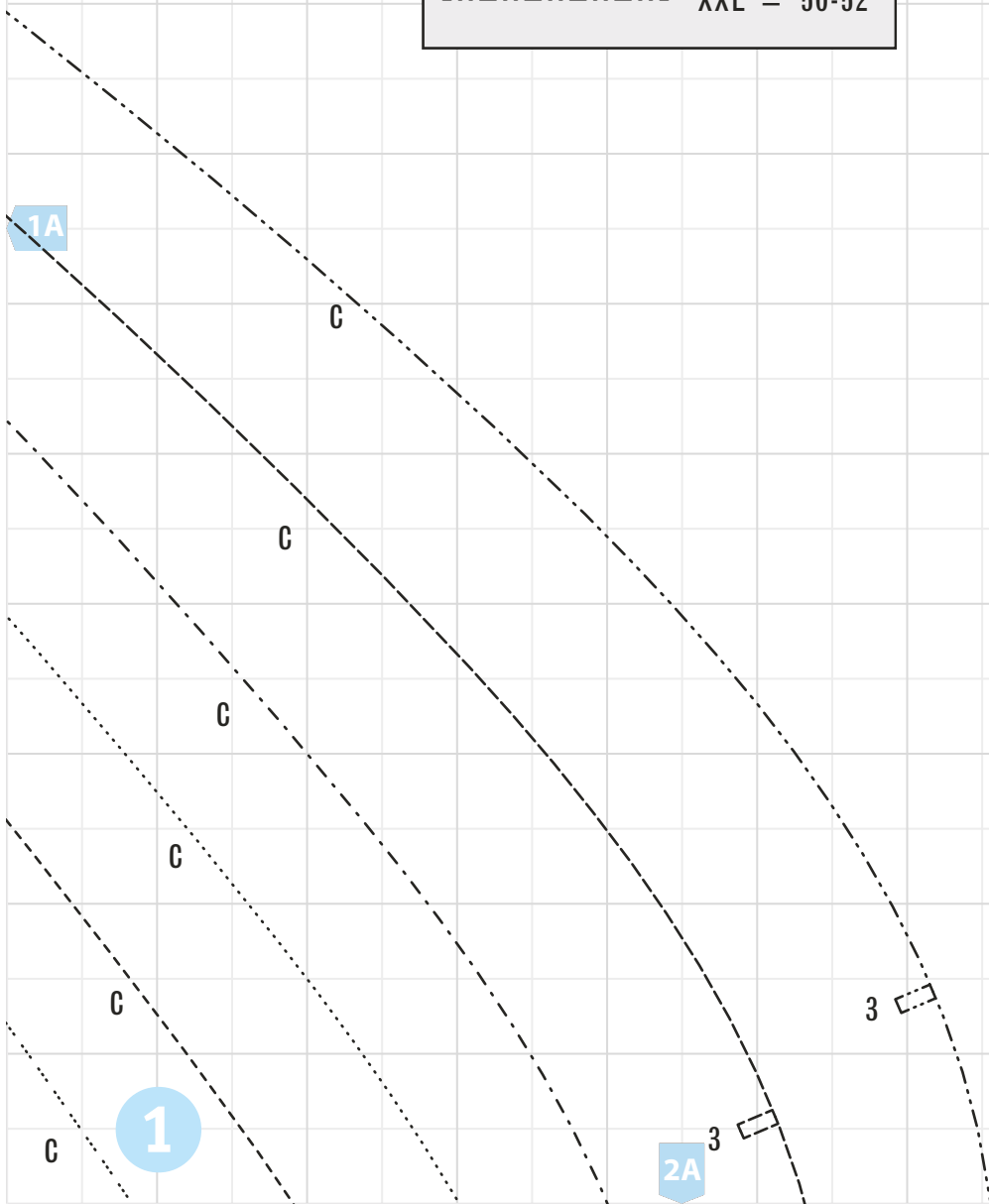

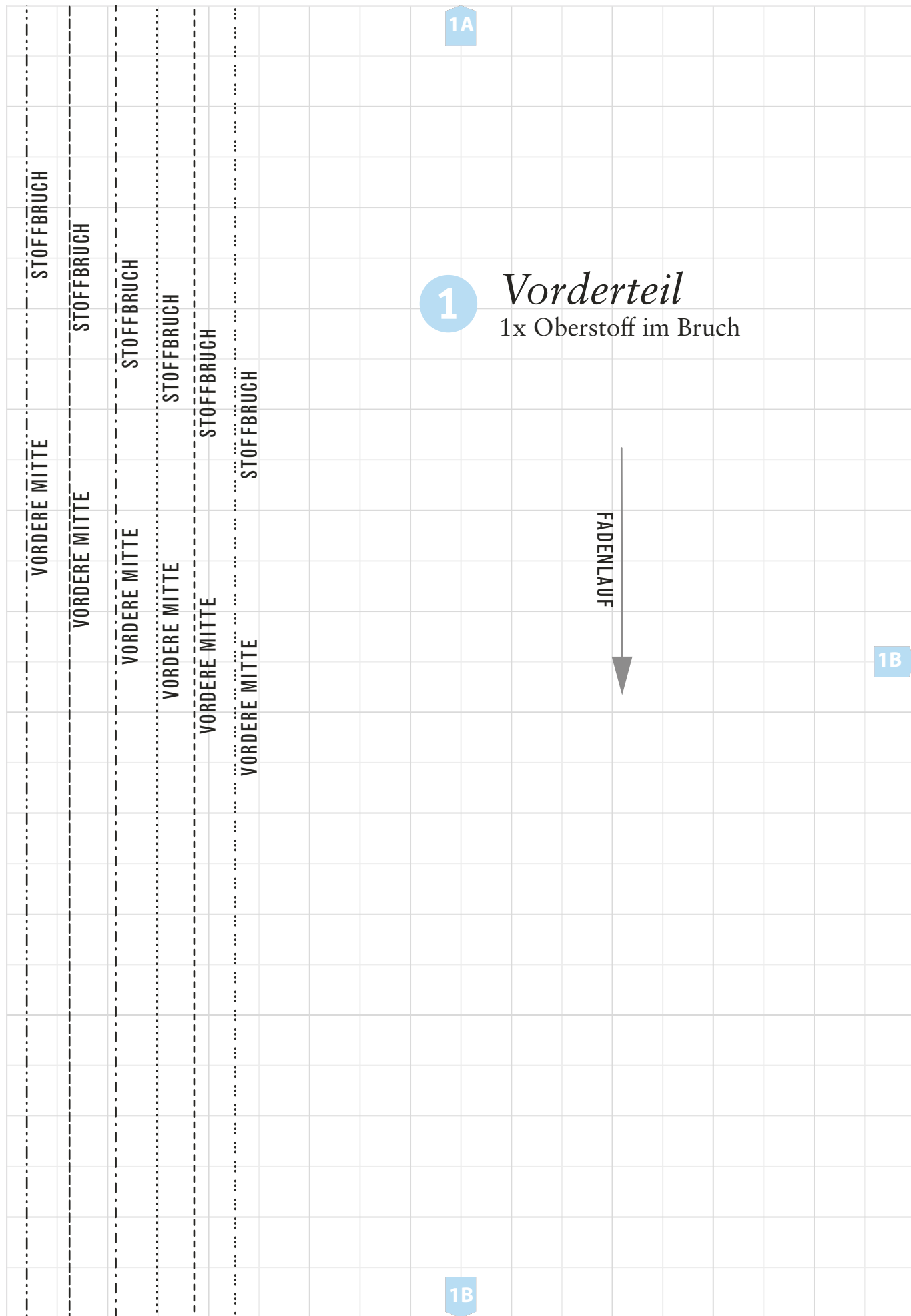

1

Vorderteil

1x Oberstoff im Bruch

1A

1B

1B

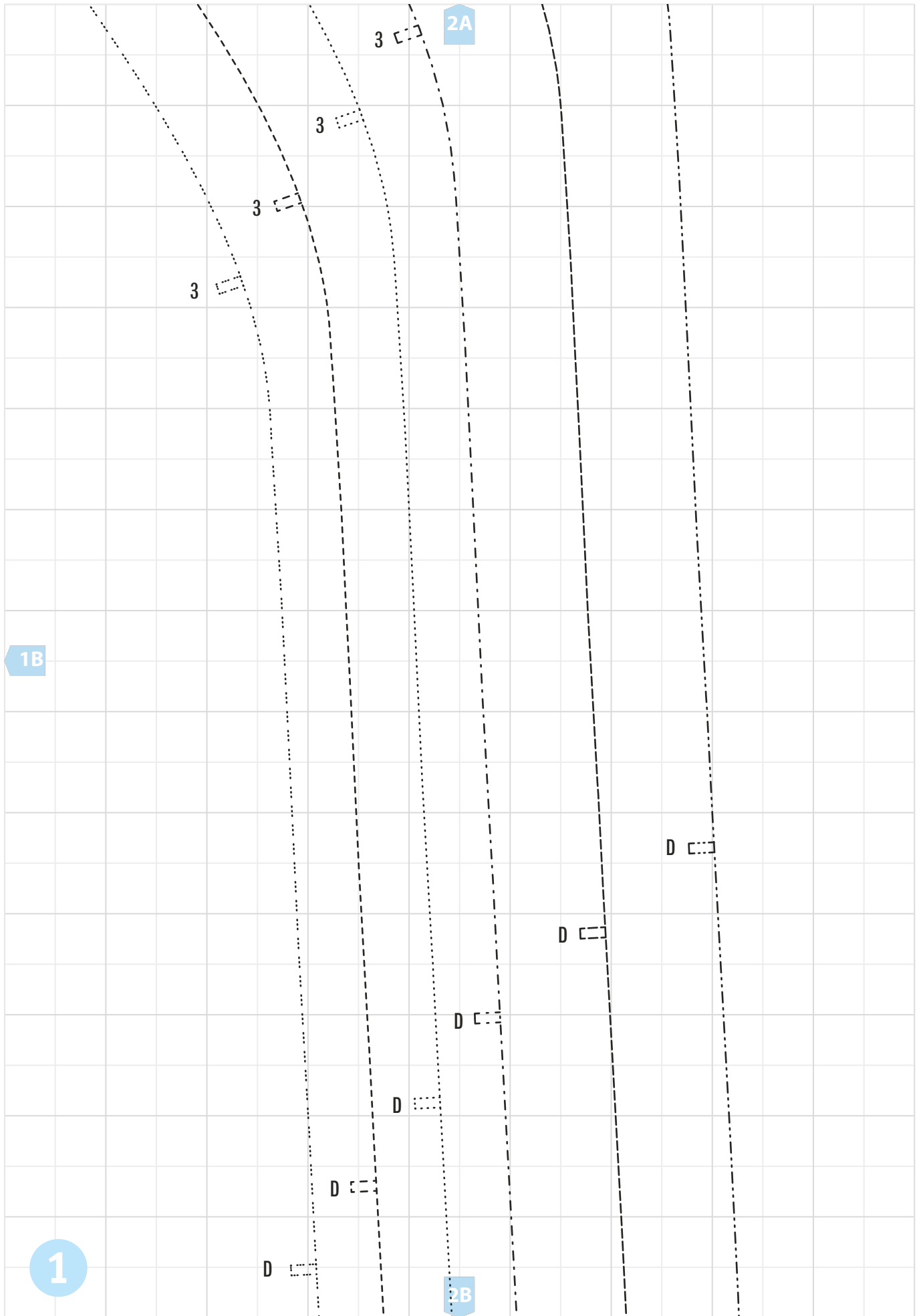

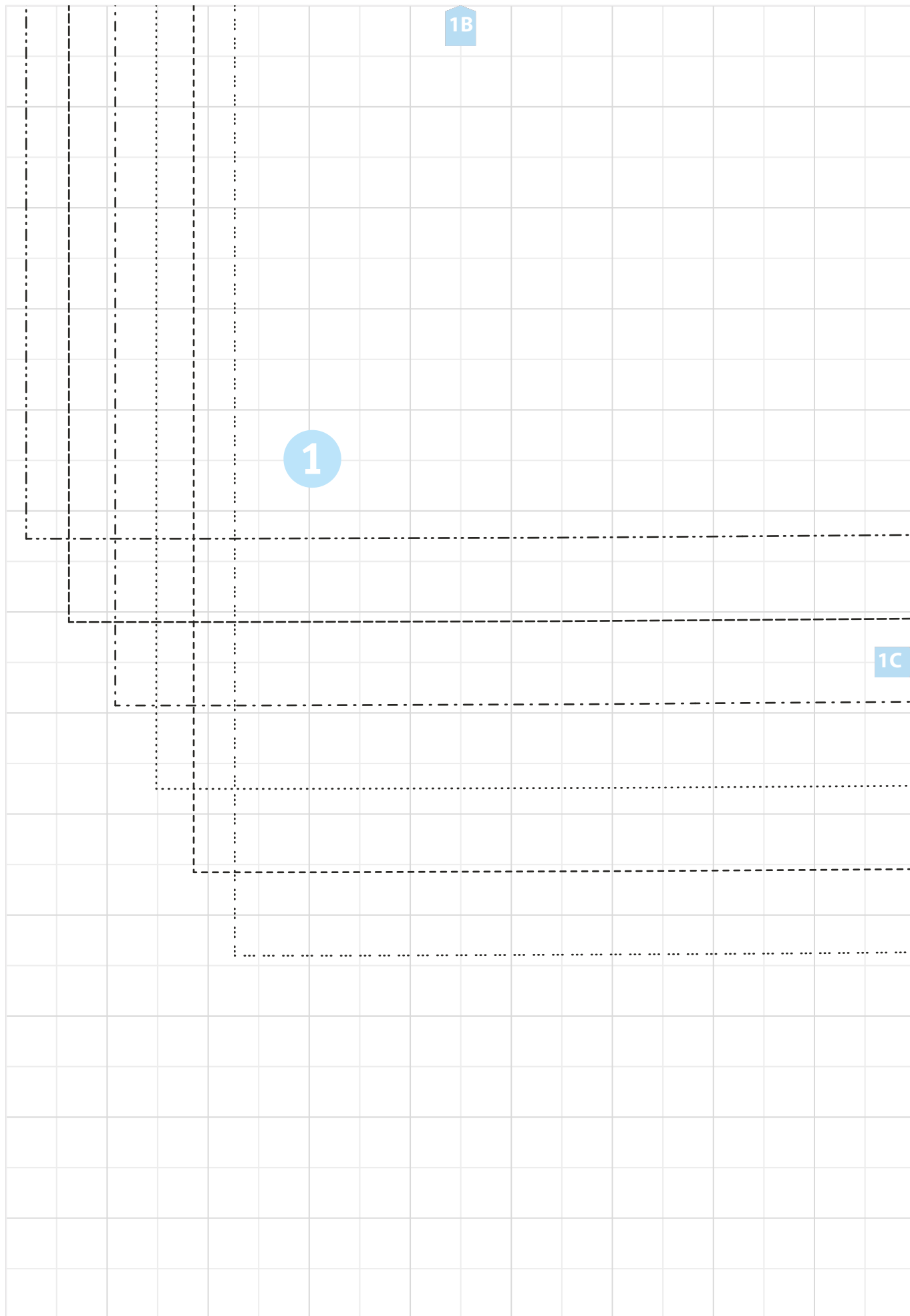

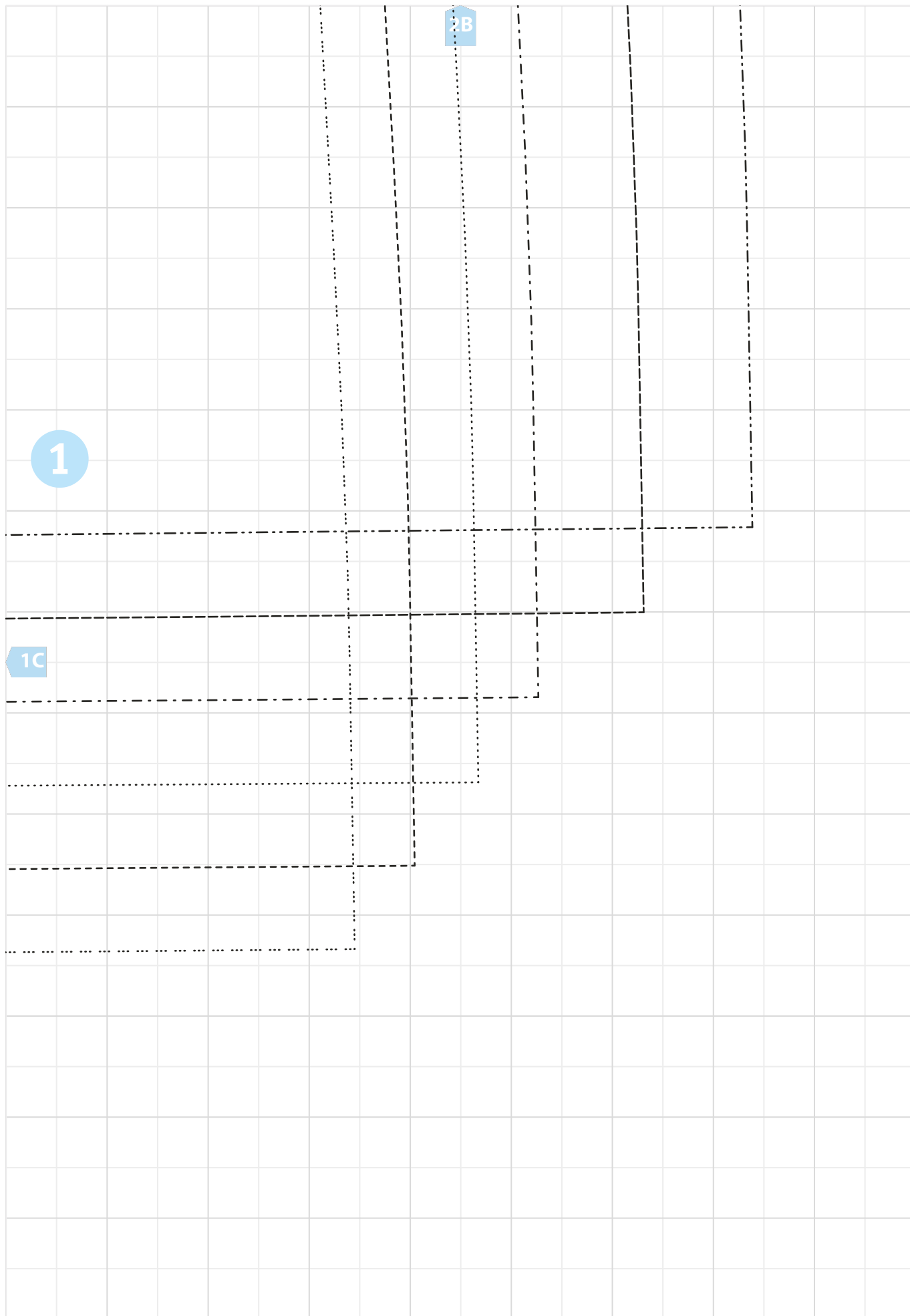

Größen	
.....	XS = 32
-----	S = 34-36
.....	M = 38-40
-----	L = 42-44
-----	XL = 46-48
-----	XXL = 50-52

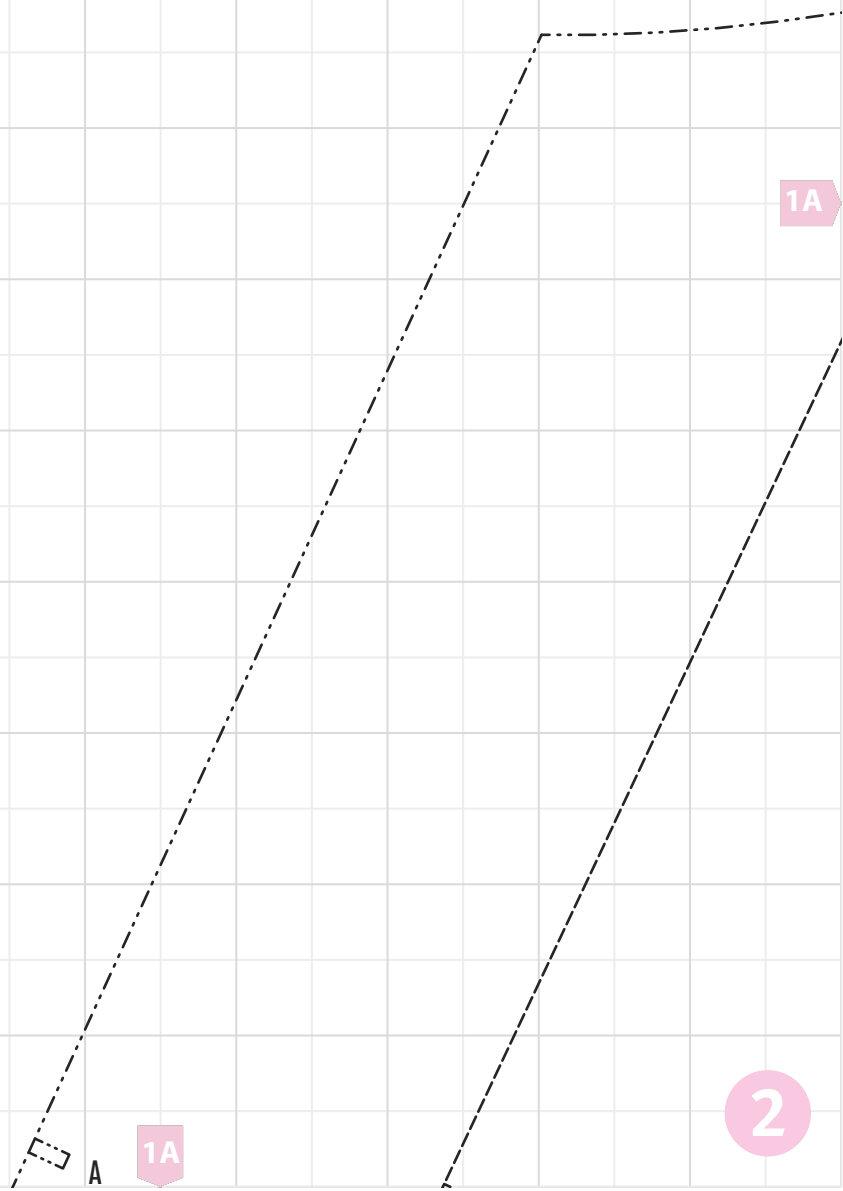

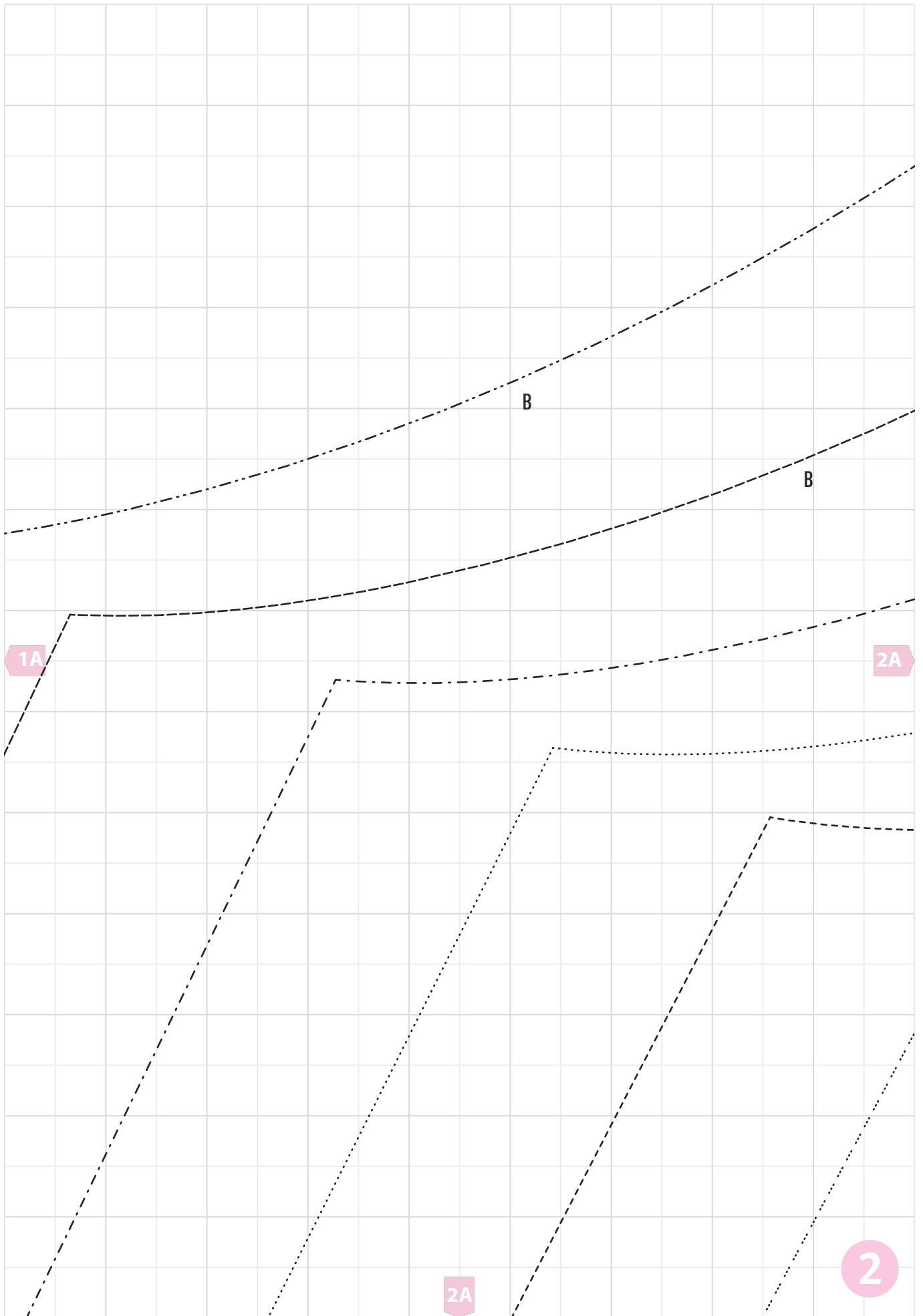

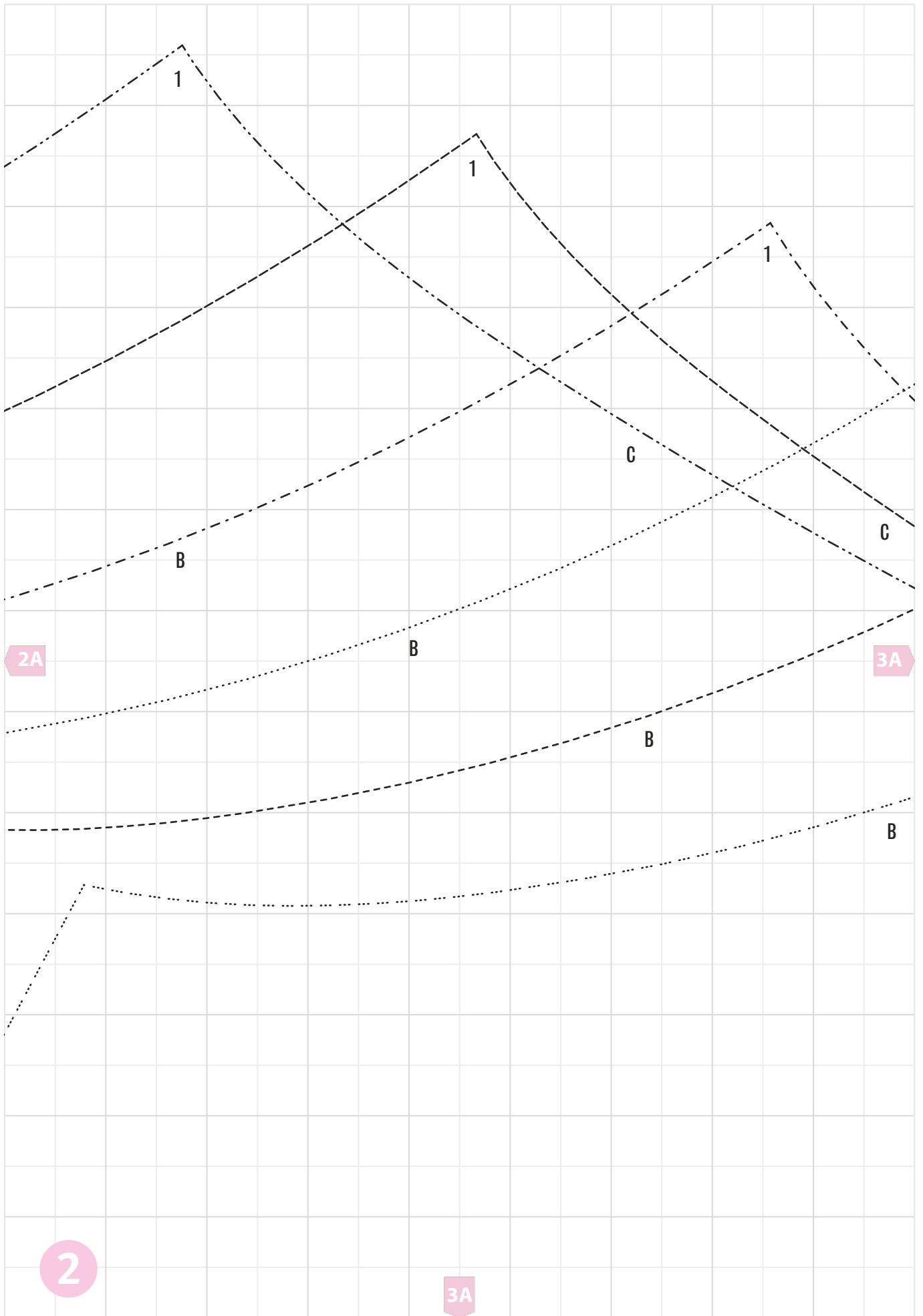

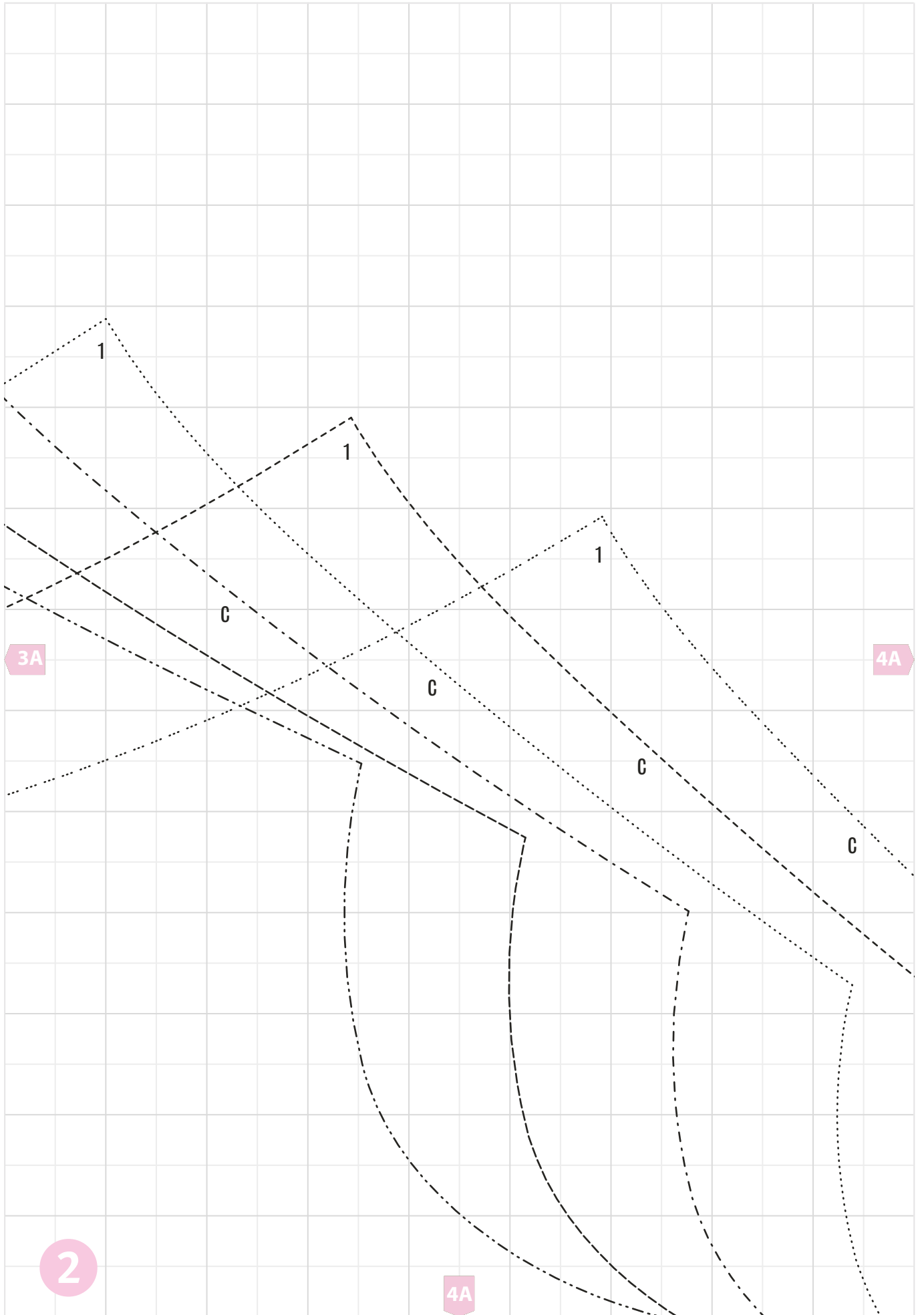

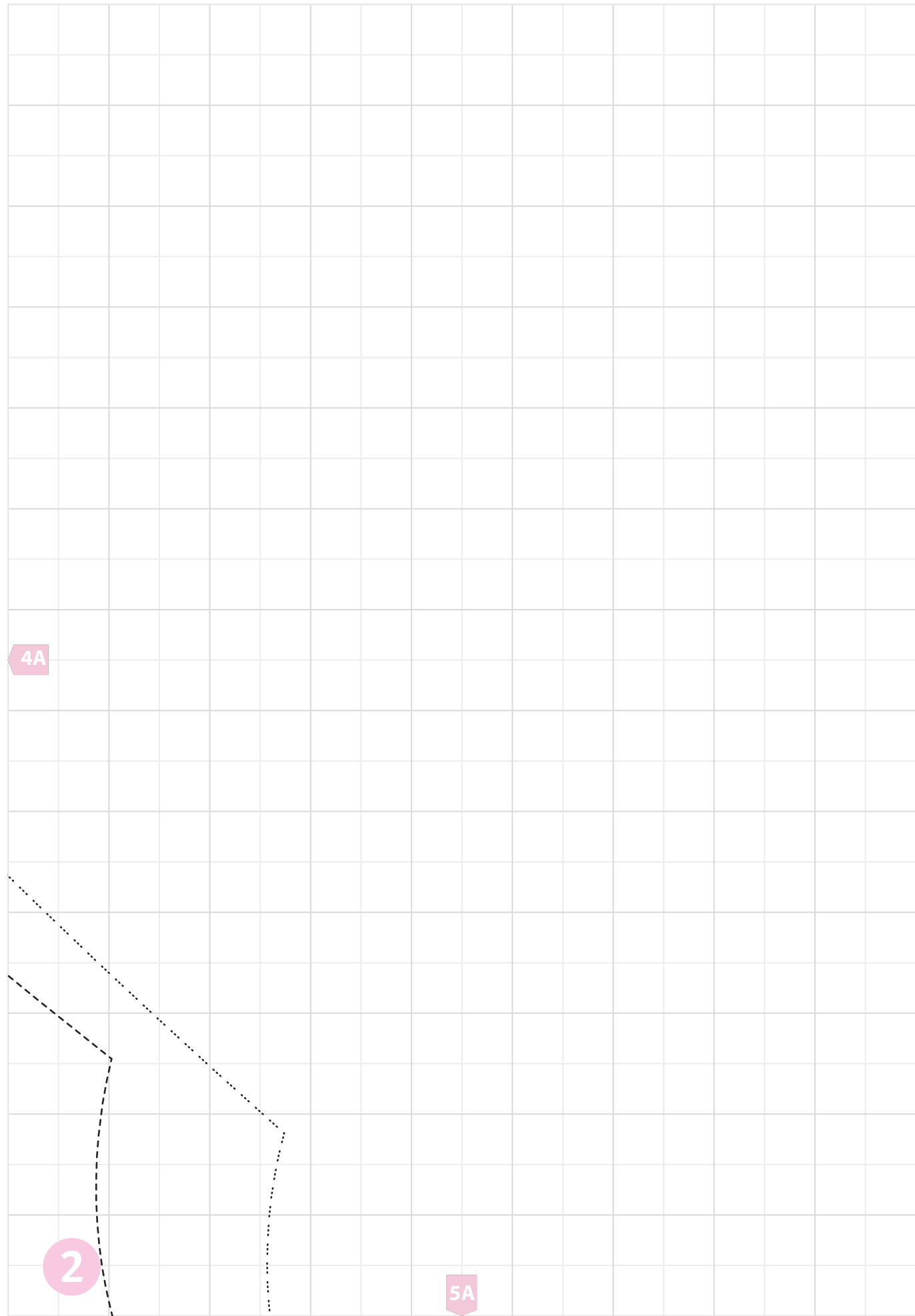

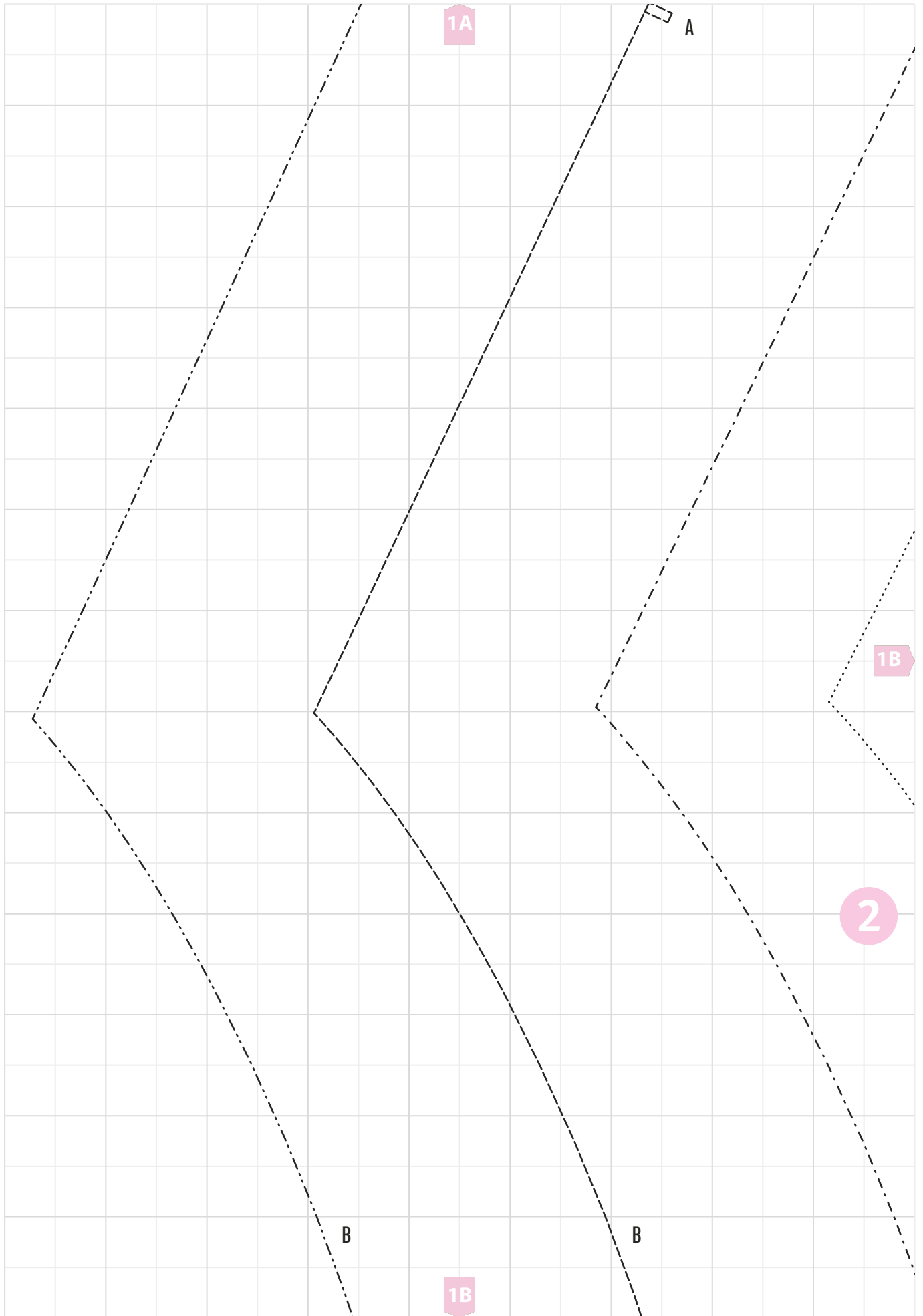

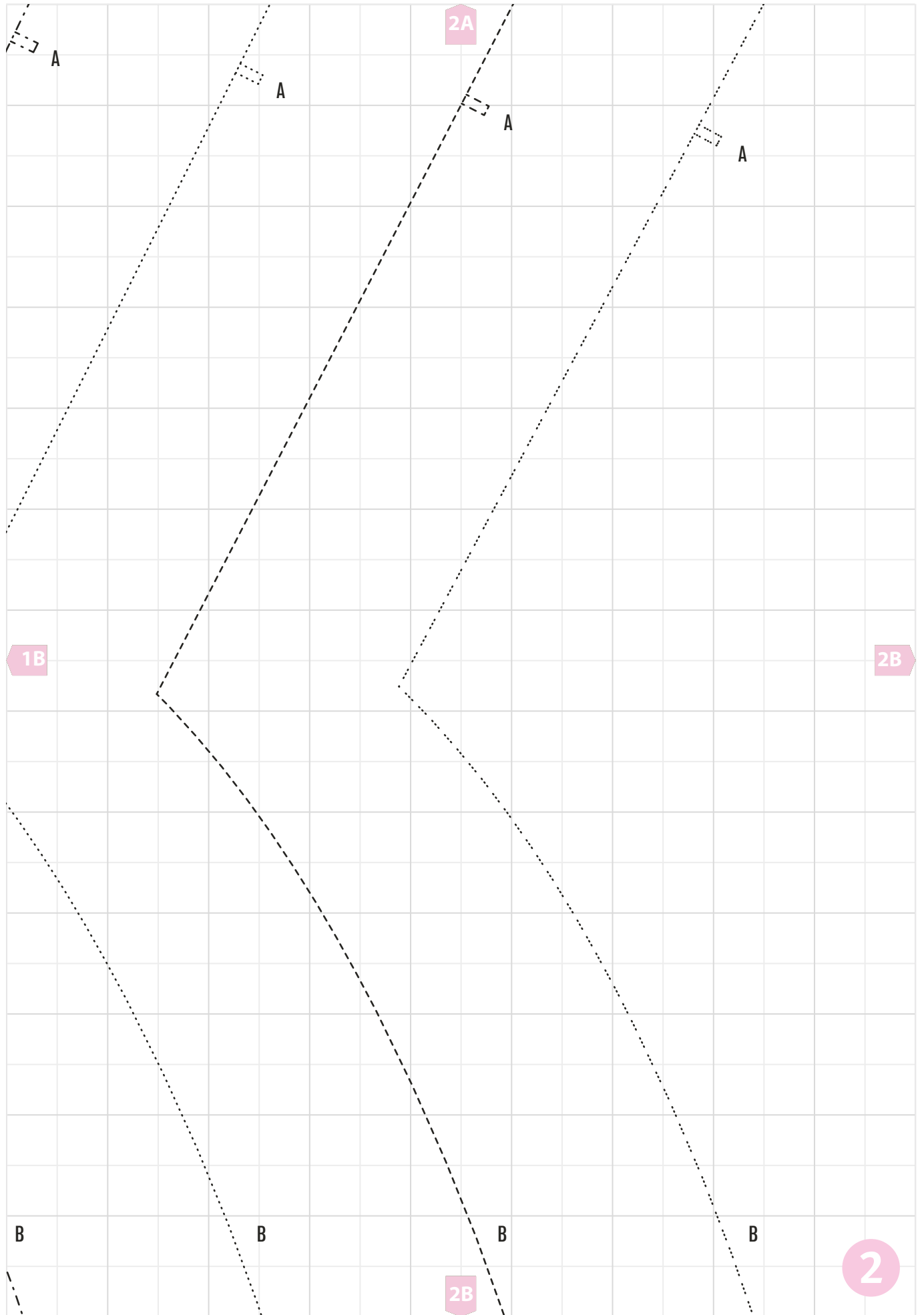

3A

2 *Rückenteil*
1x Oberstoff im Bruch

FADENLAUF

2B

3B

3B

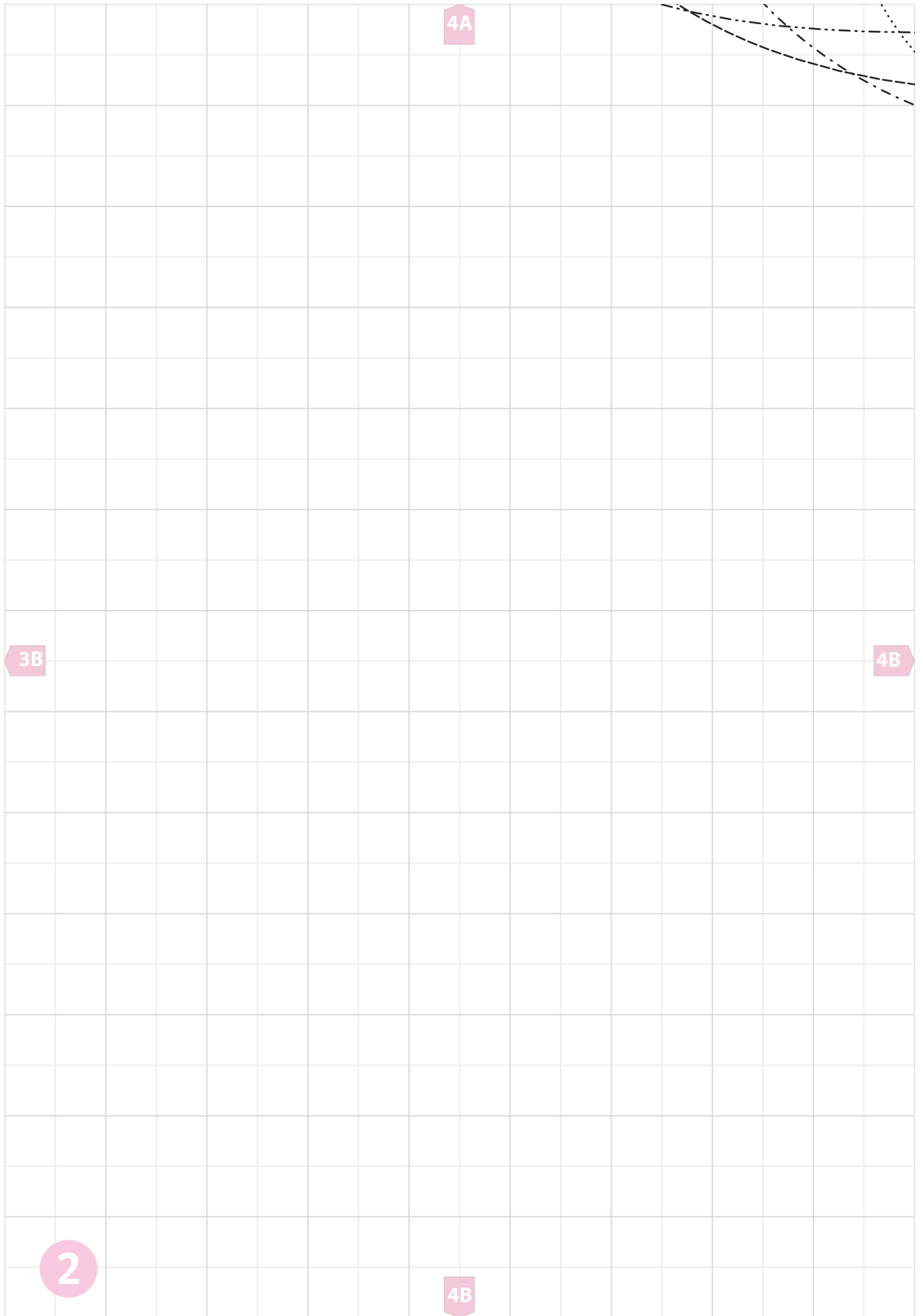

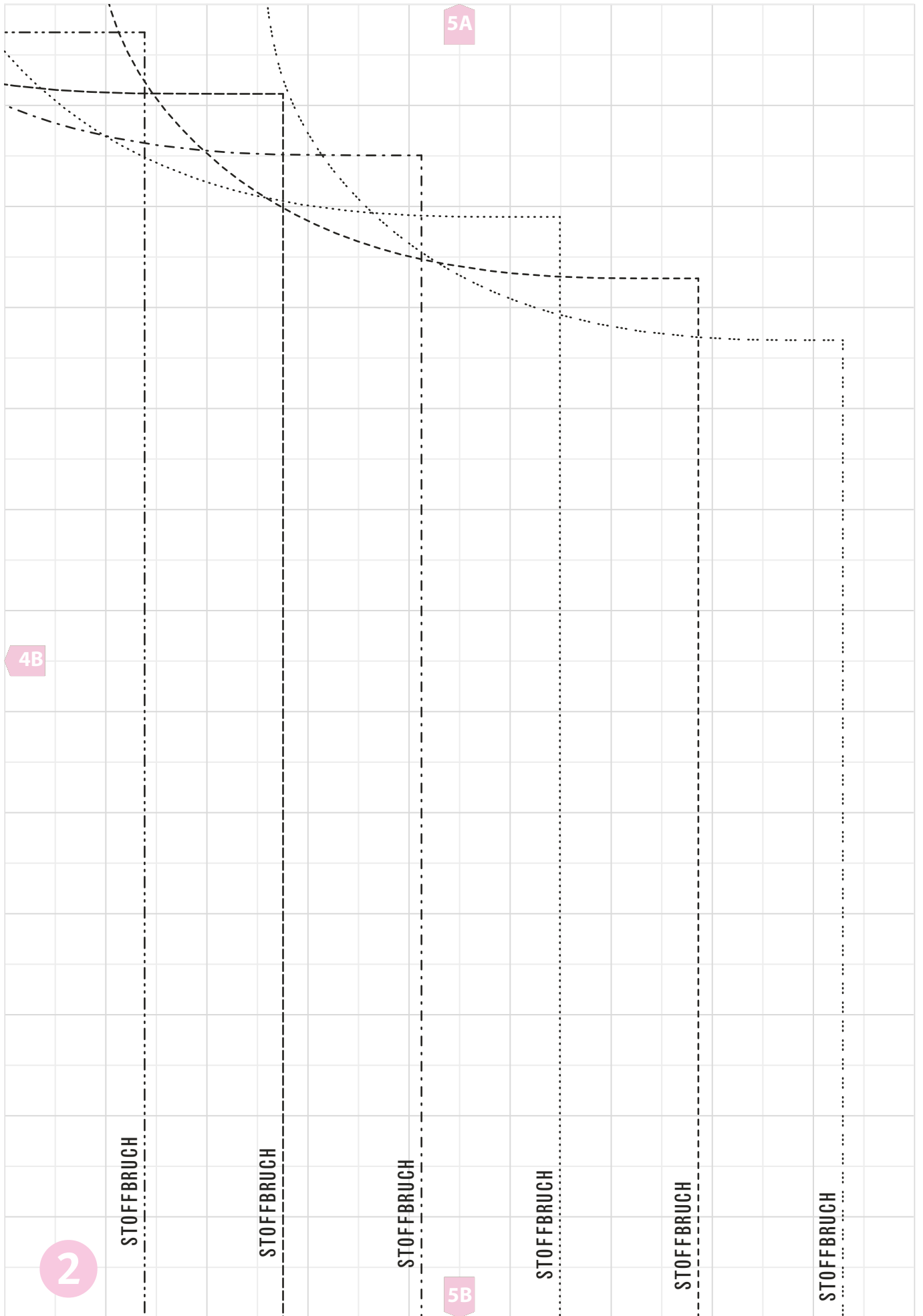

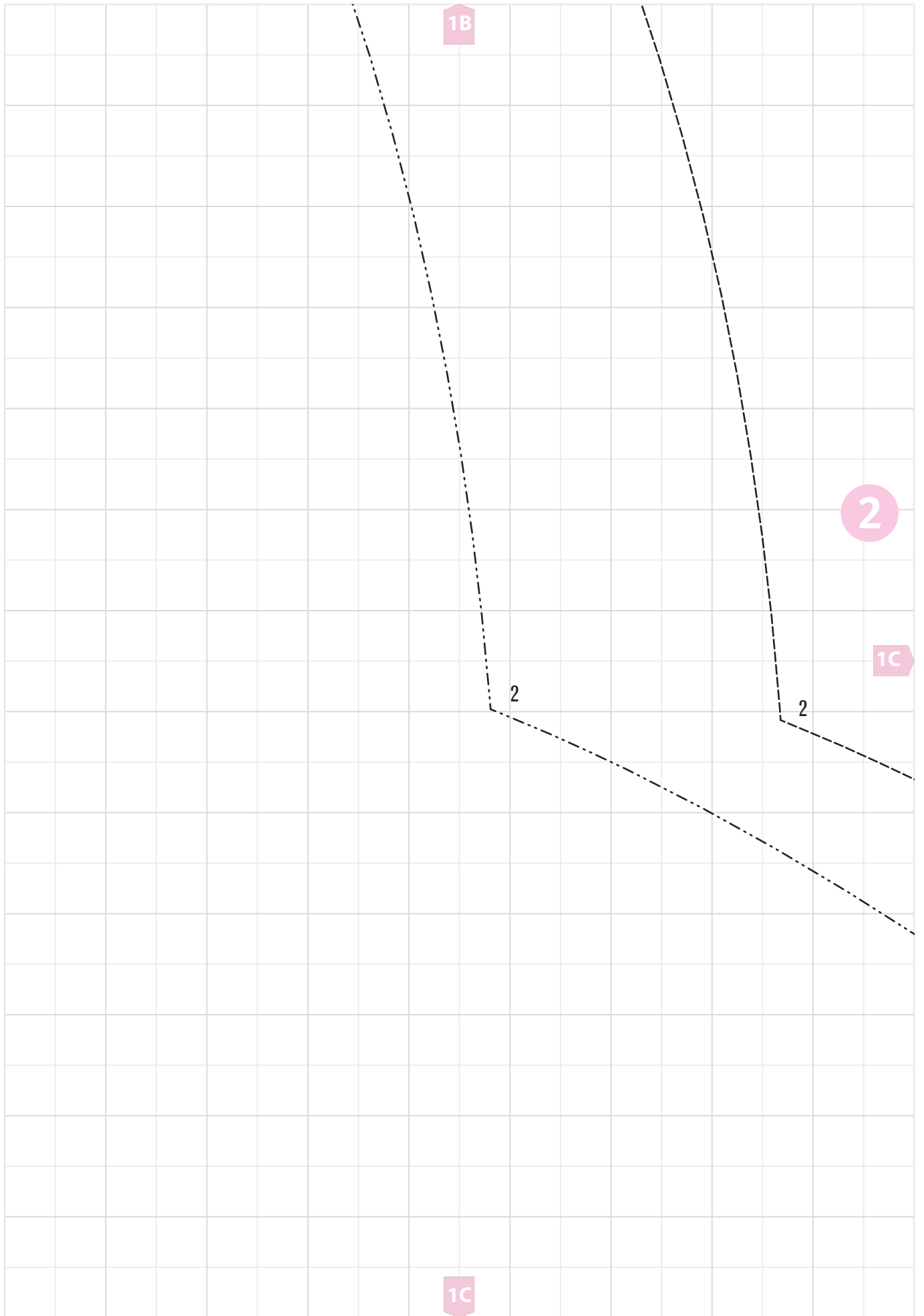

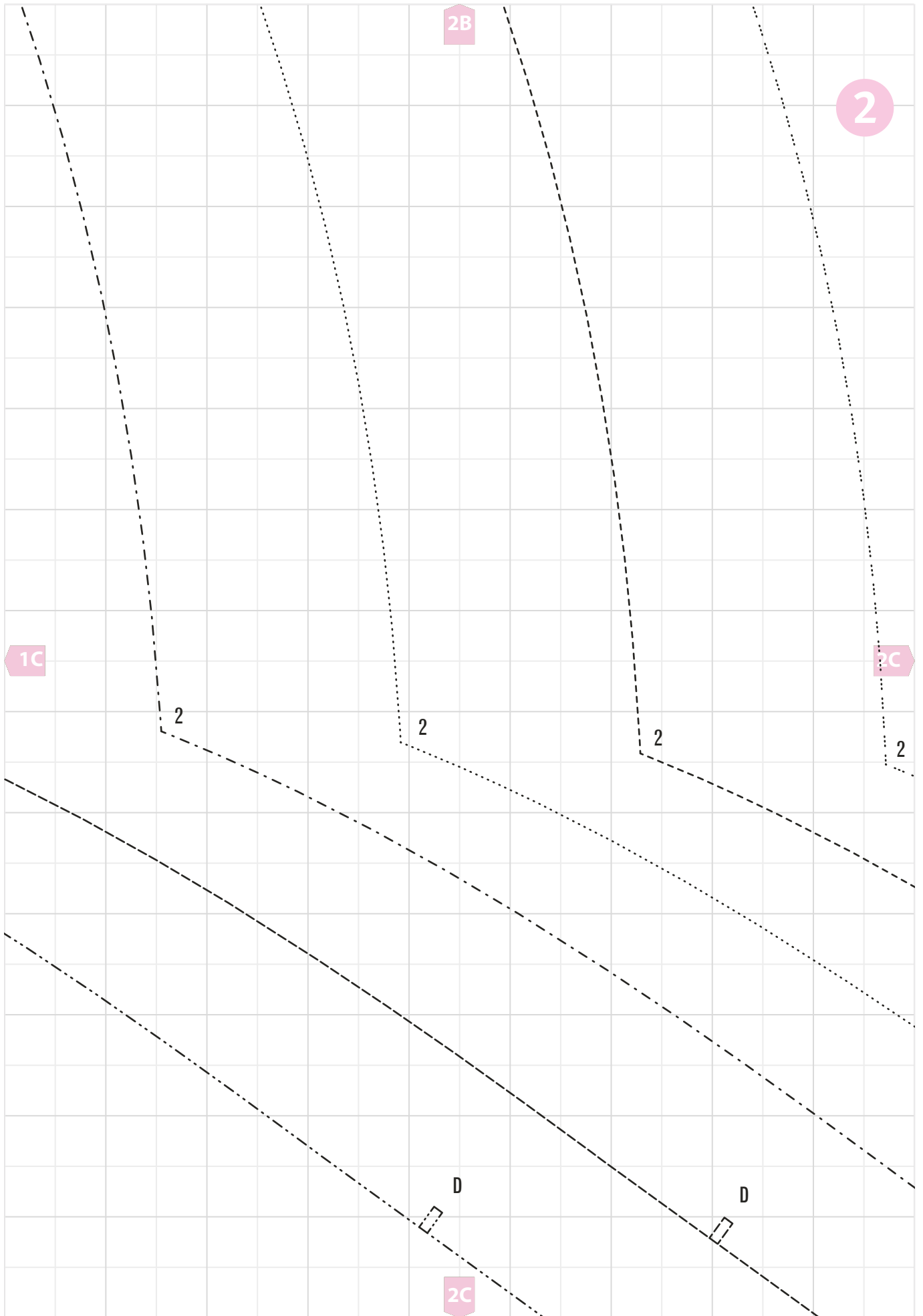

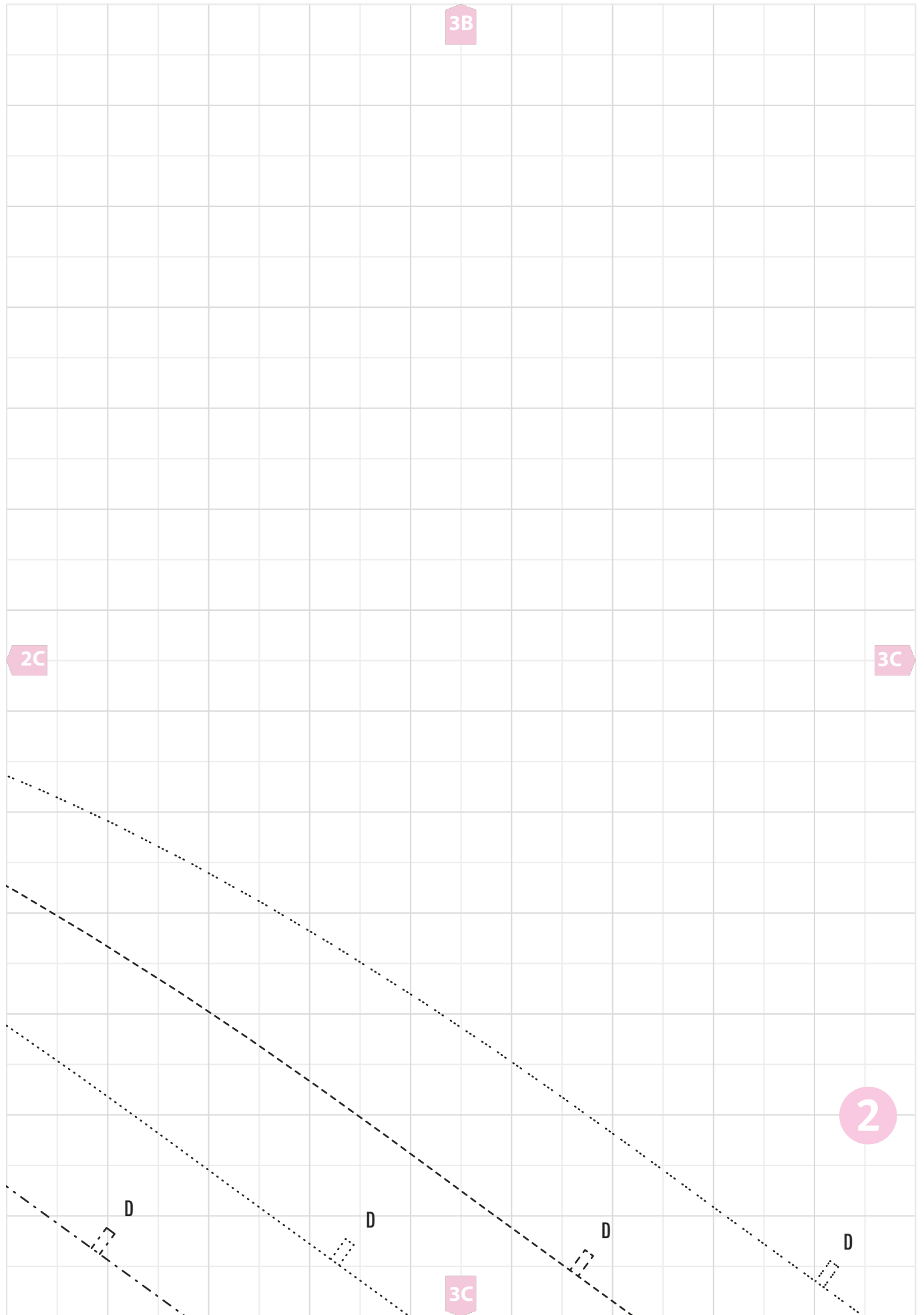

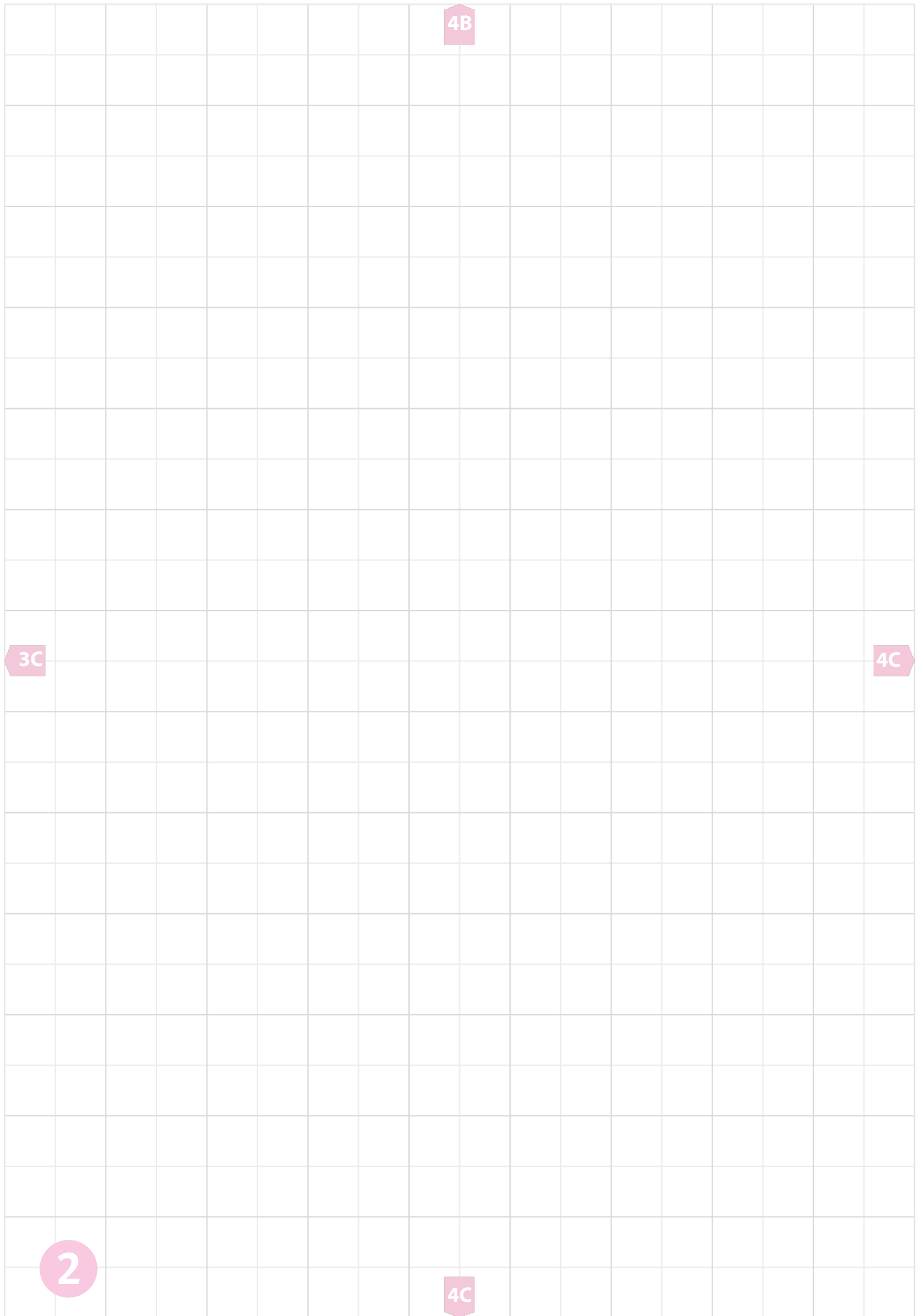

2

4B

3C

4C

4C

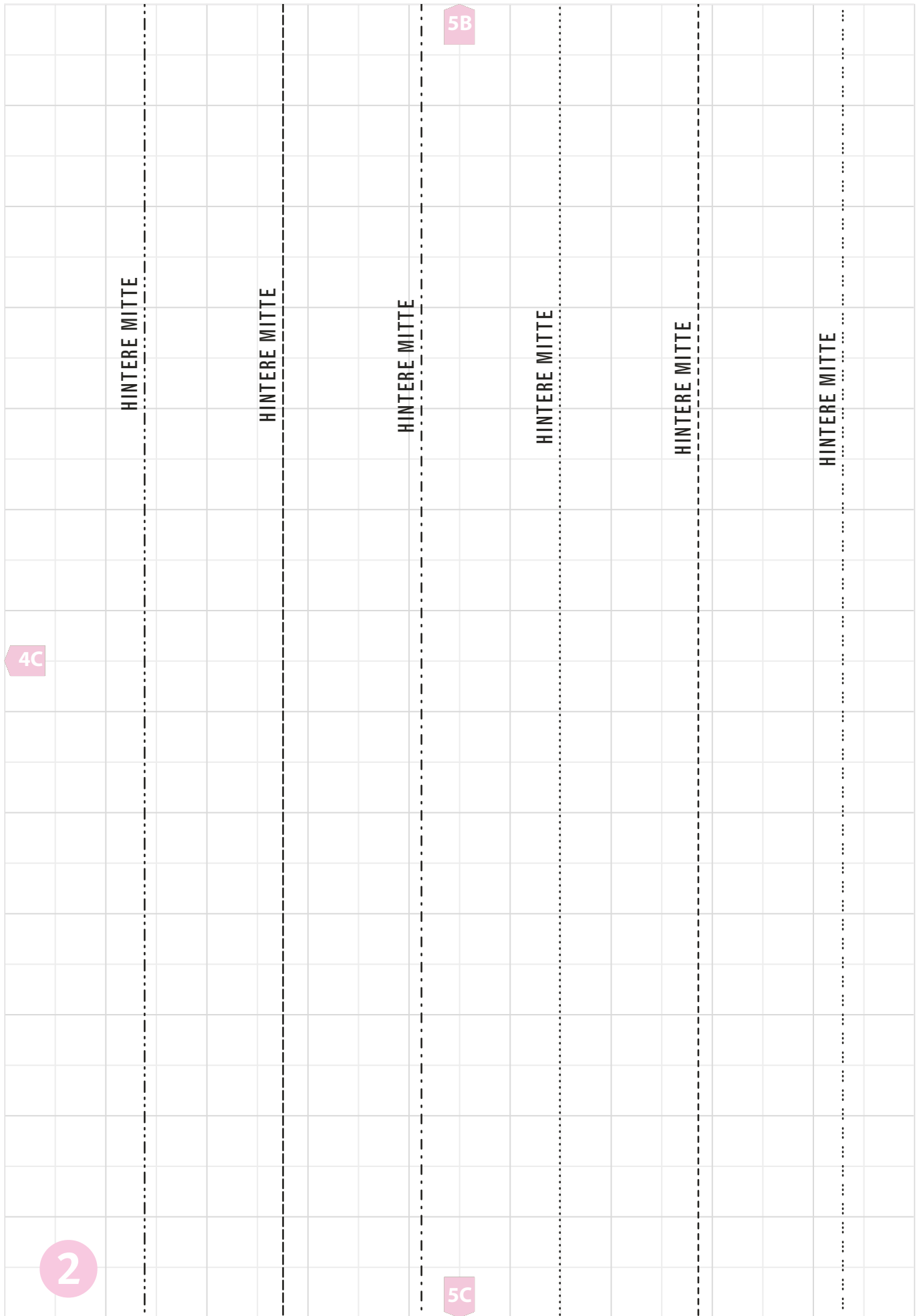

HINTERE MITTE

HINTERE MITTE

HINTERE MITTE

HINTERE MITTE

HINTERE MITTE

HINTERE MITTE

2

5B

4C

5C

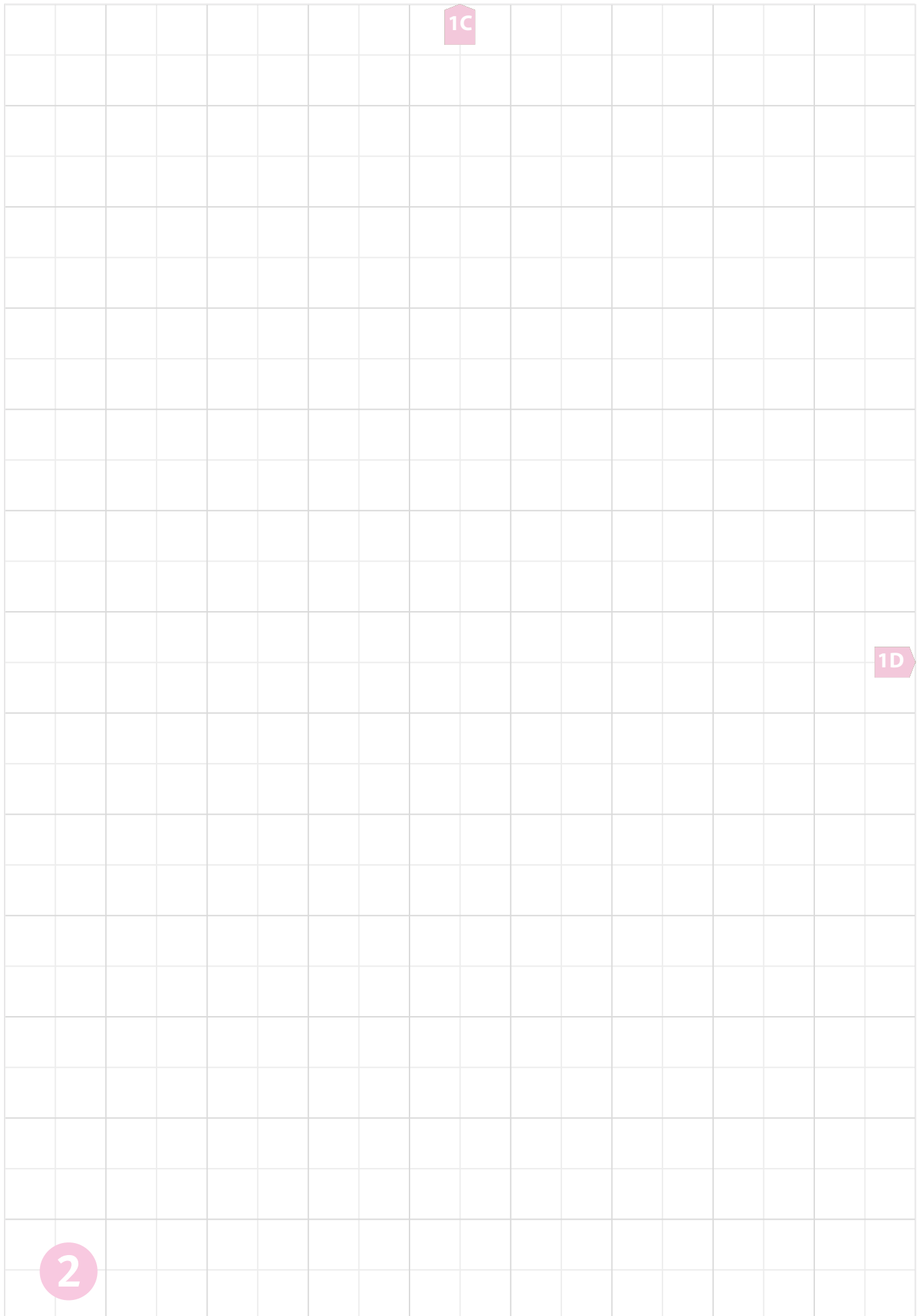

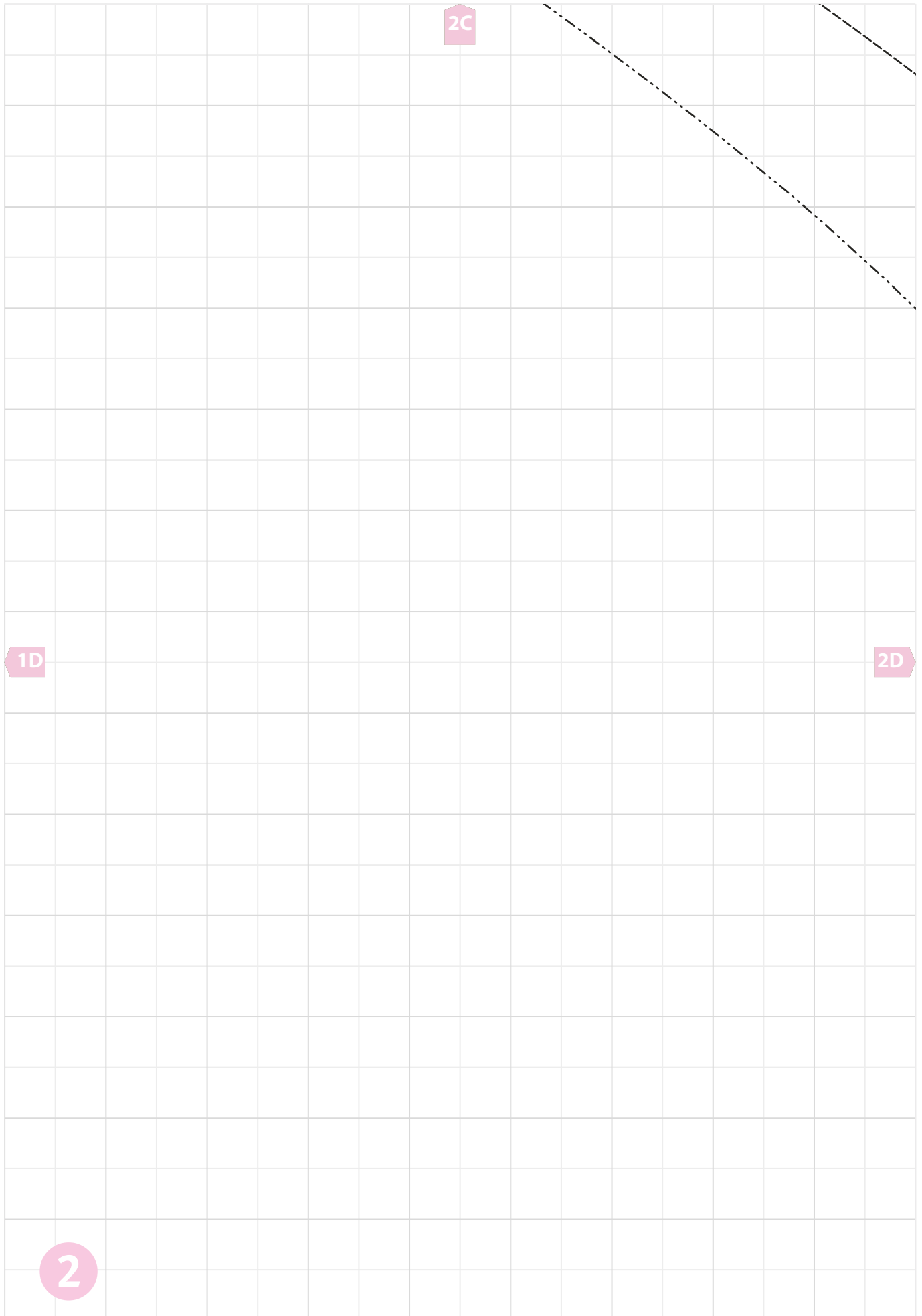

2C

1D

2D

2

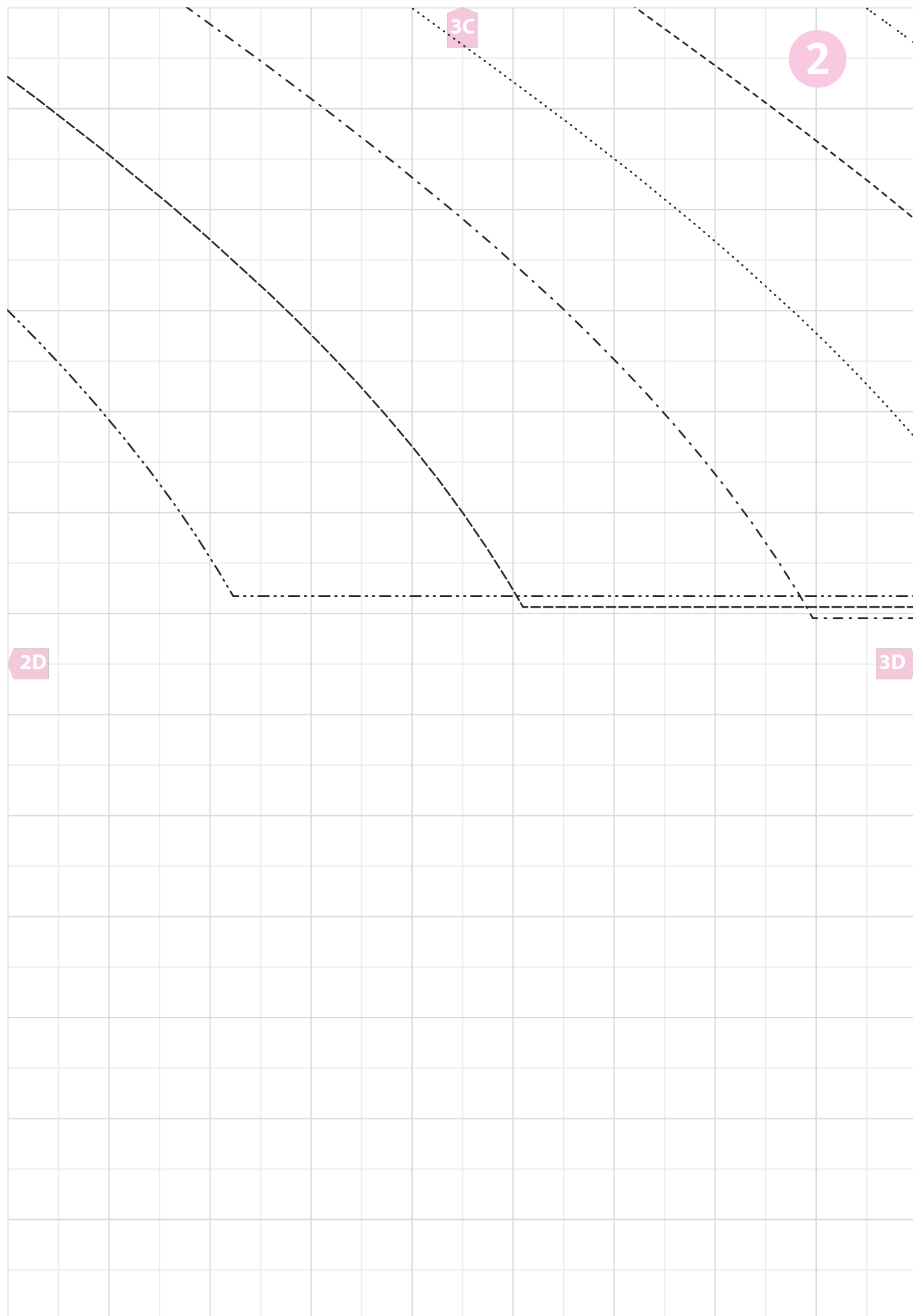

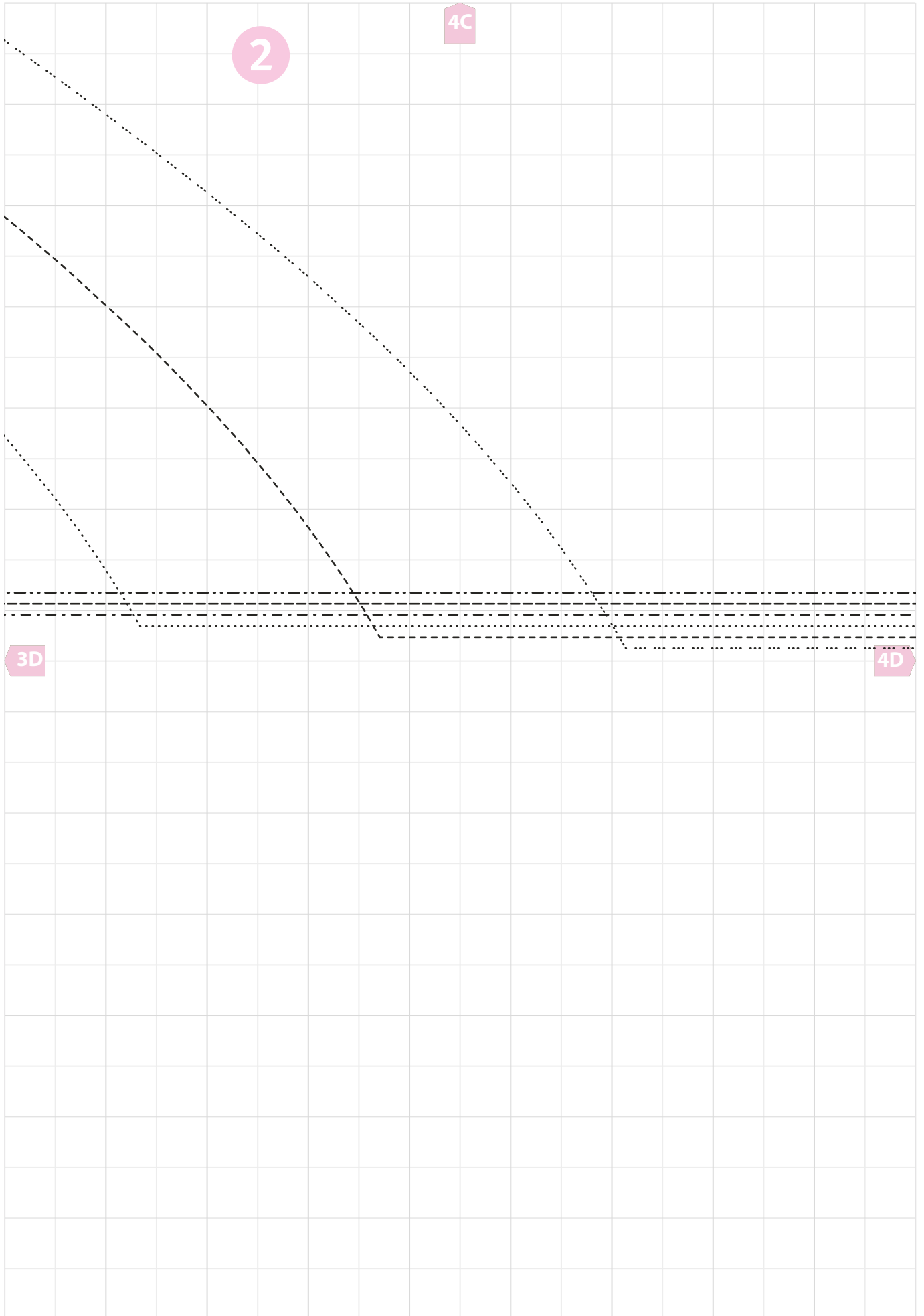

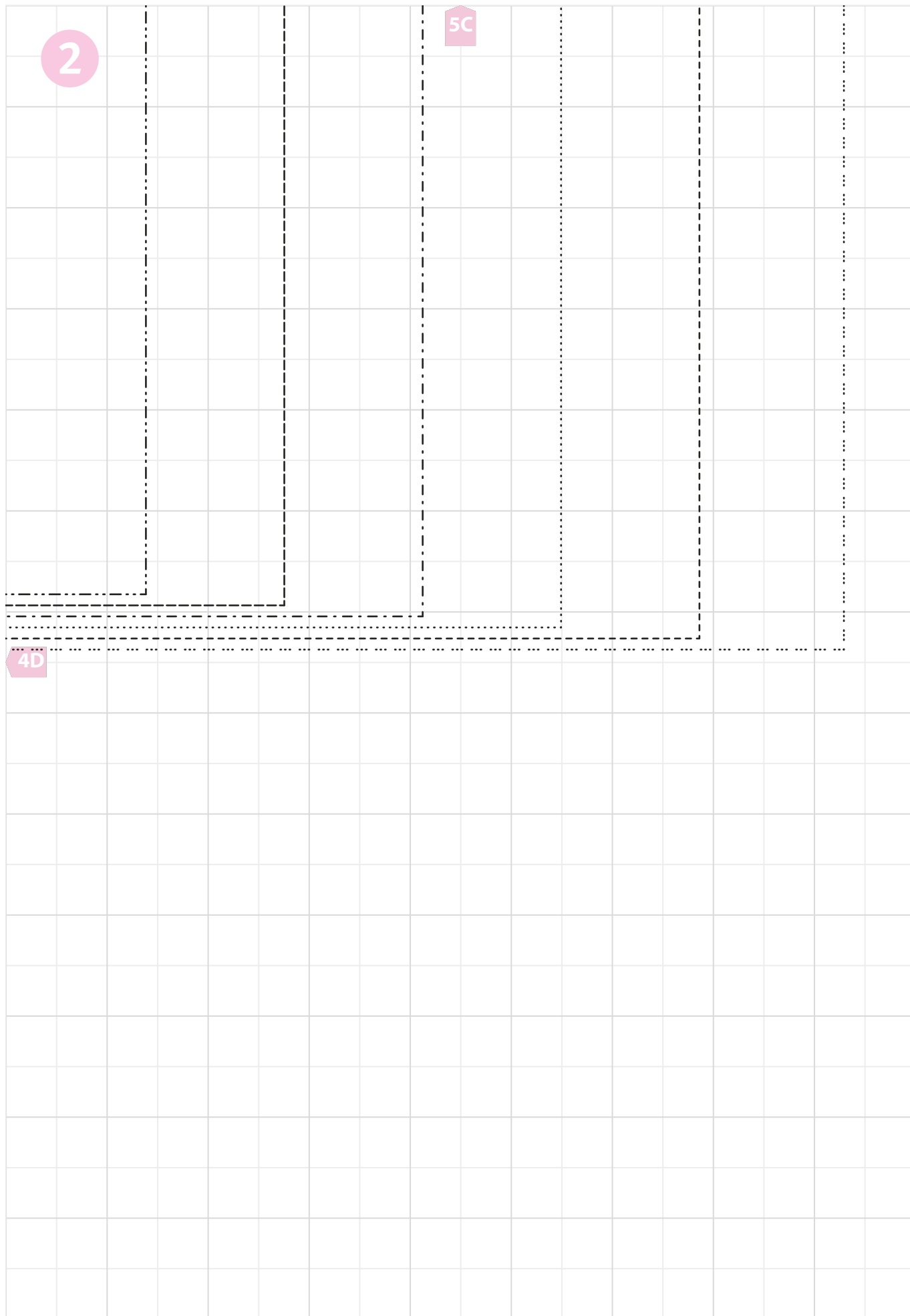

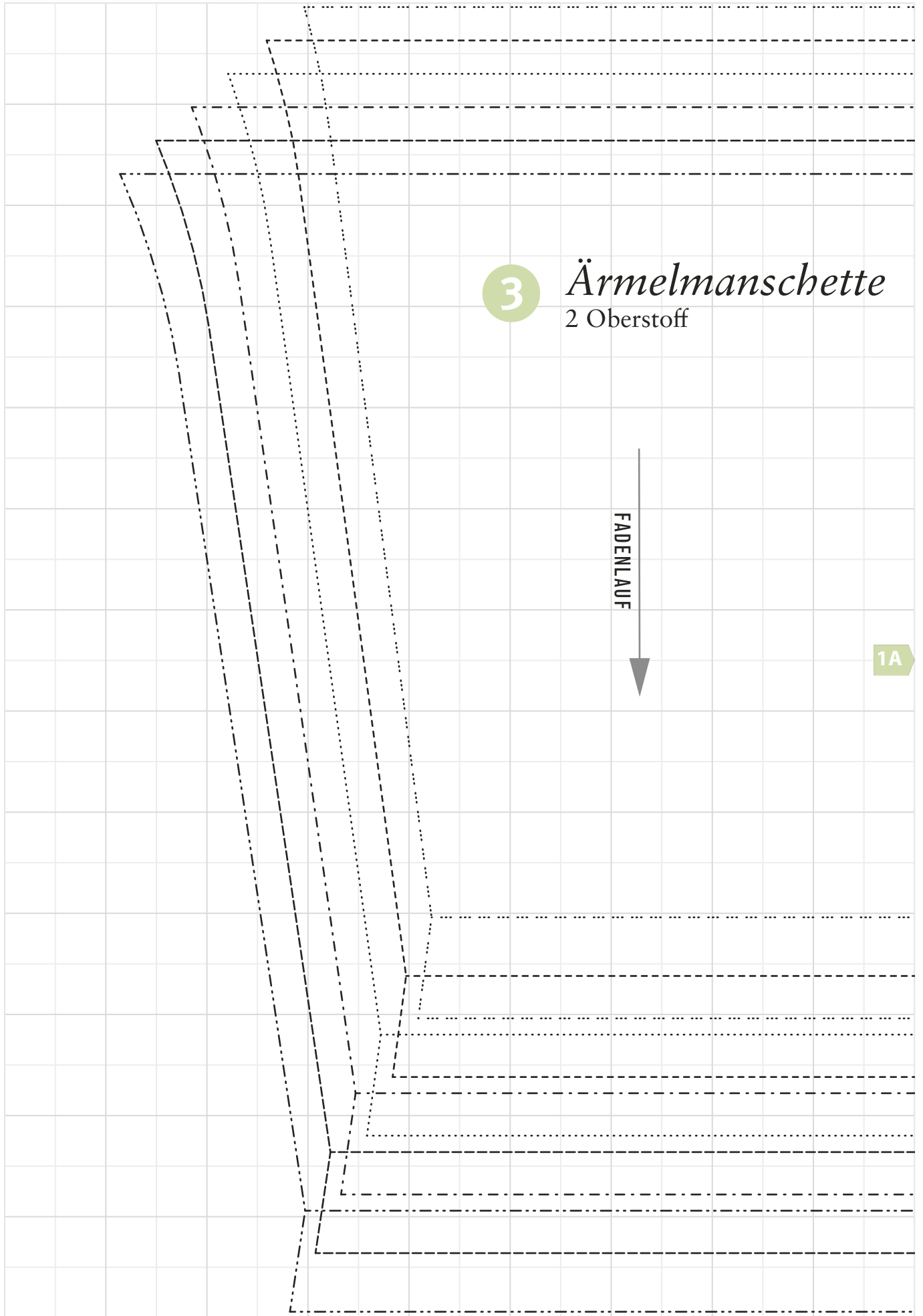

3

Ärmelmanschette

2 Oberstoff

FADENLAUF

1A

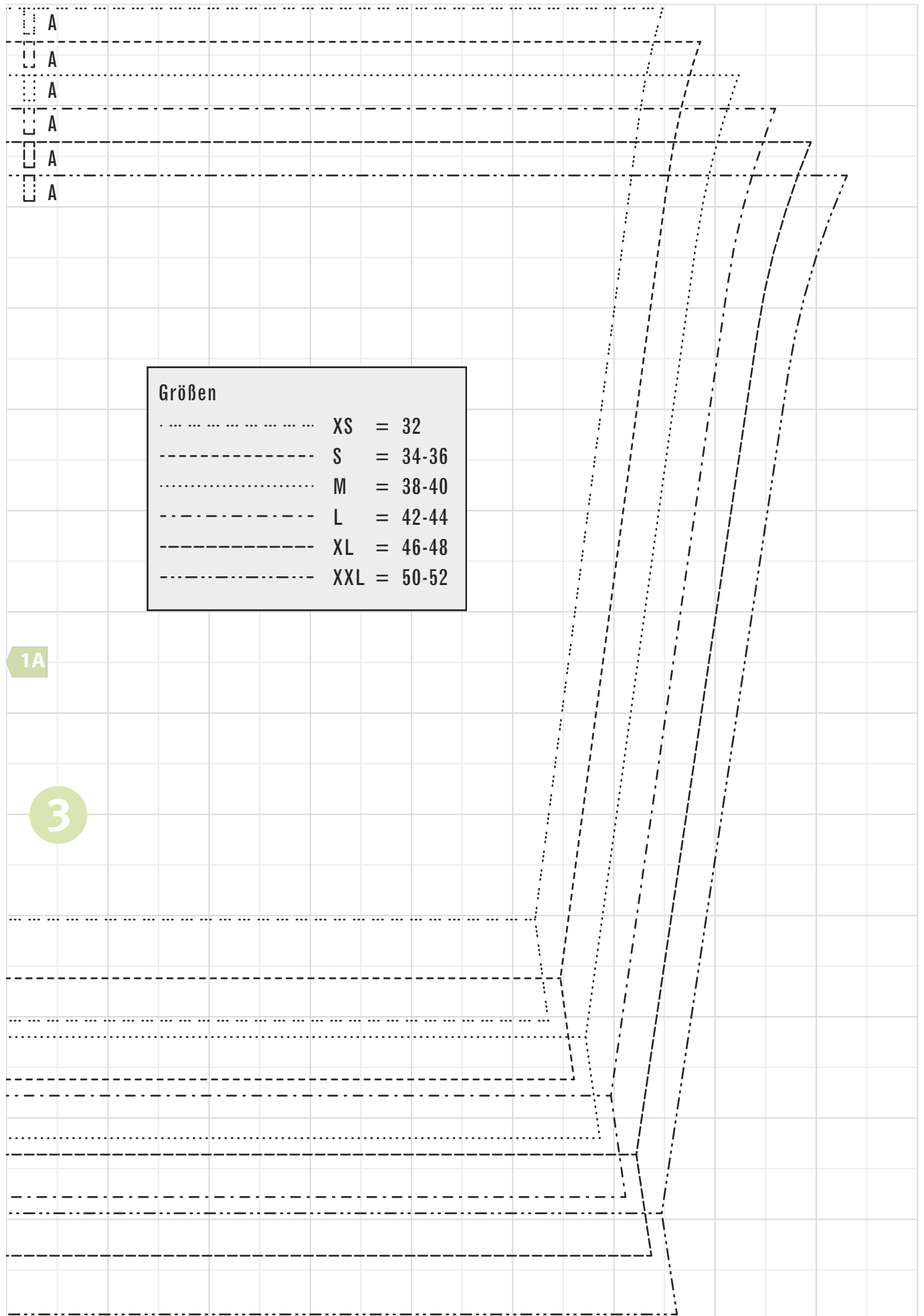

Größen	
.....	XS = 32
-----	S = 34-36
.....	M = 38-40
-----	L = 42-44
-----	XL = 46-48
-----	XXL = 50-52

1A

3

Größen	
..... XS	= 32
----- S	= 34-36
..... M	= 38-40
- - - - - L	= 42-44
----- XL	= 46-48
..... XXL	= 50-52

4

4

4

1A

4

4

4

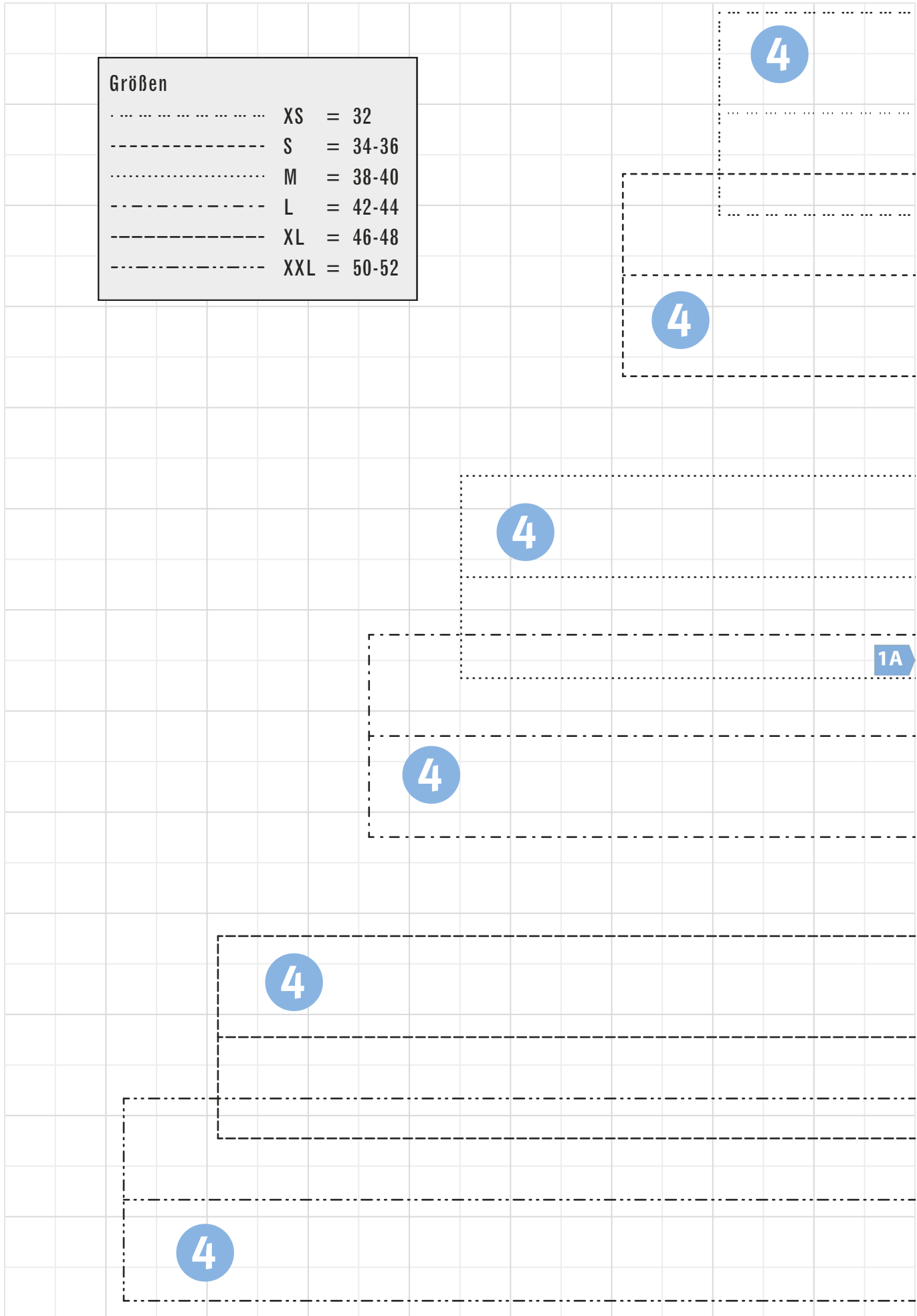

4

4 *Halslochbündchen*
1x Oberstoff

4

1A

2A

4 *Halslochbündchen*
1x Oberstoff

4

4 *Halslochbündchen*
1x Oberstoff

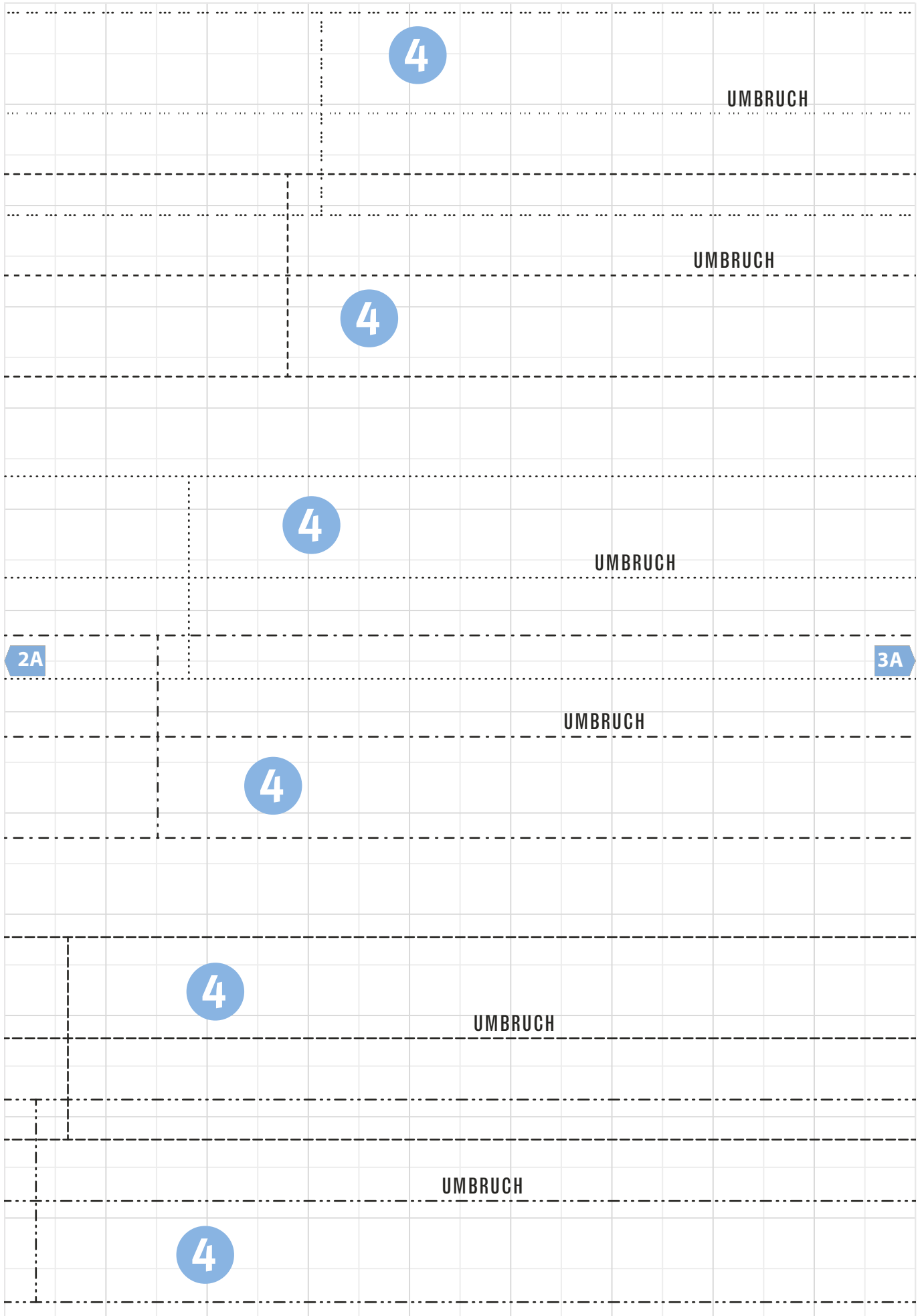

4 Halslochbündchen
1x Oberstoff

4

4 Halslochbündchen
1x Oberstoff

3A

4

4 Halslochbündchen
1x Oberstoff

4

Größen	
.....	XS = 32
-----	S = 34-36
.....	M = 38-40
- - - - -	L = 42-44
-----	XL = 46-48
.....	XXL = 50-52

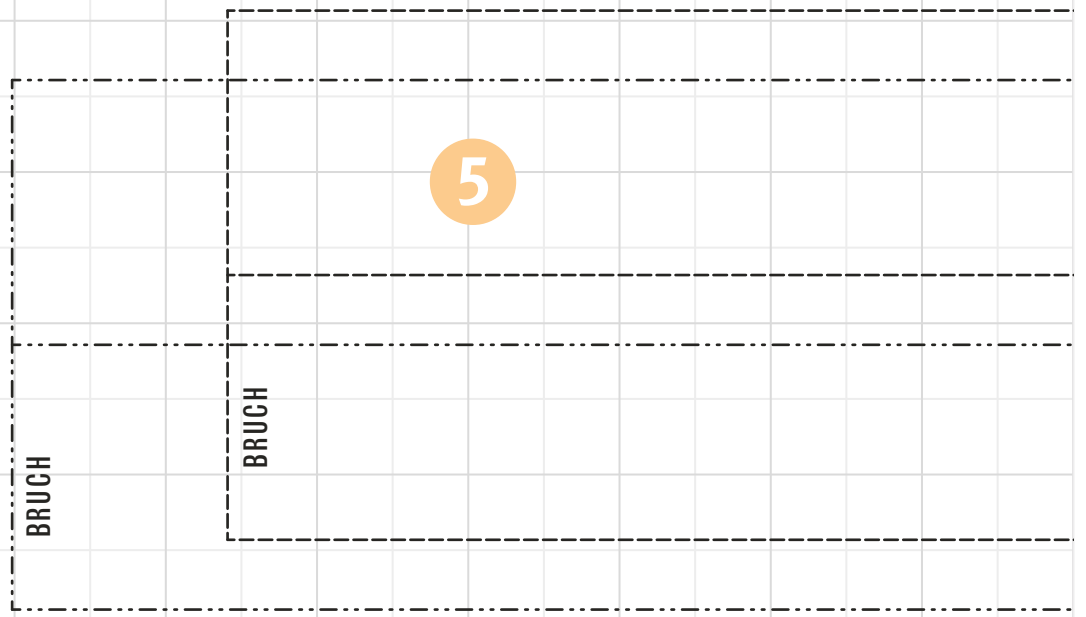
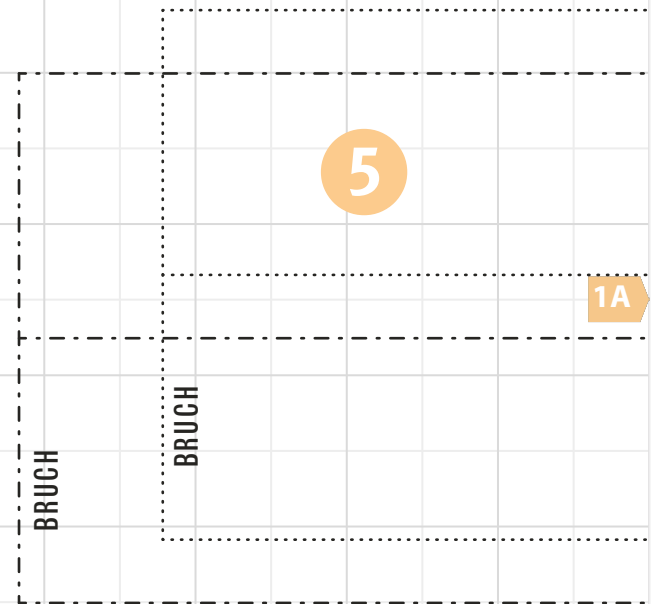
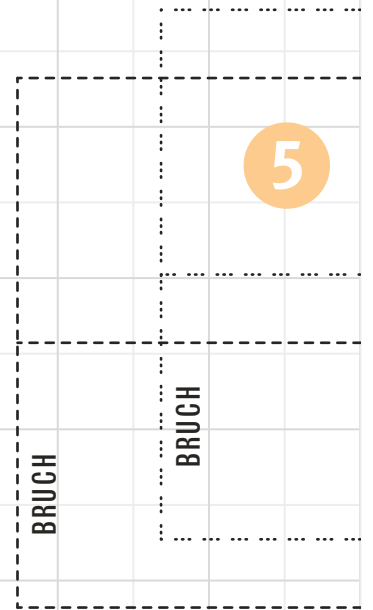

5

Saumbund

1x Oberstoff im Bruch

5

Saumbund

1x Oberstoff im Bruch

1A

2A

5

Saumbund

1x Oberstoff im Bruch

UMBRUCH

UMBRUCH

5

UMBRUCH

UMBRUCH

2A

3A

5

UMBRUCH

UMBRUCH

5

